

connector for a2

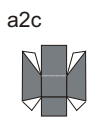

holes for assembling with Stage 2

0

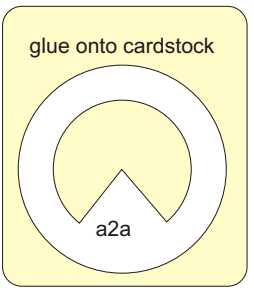
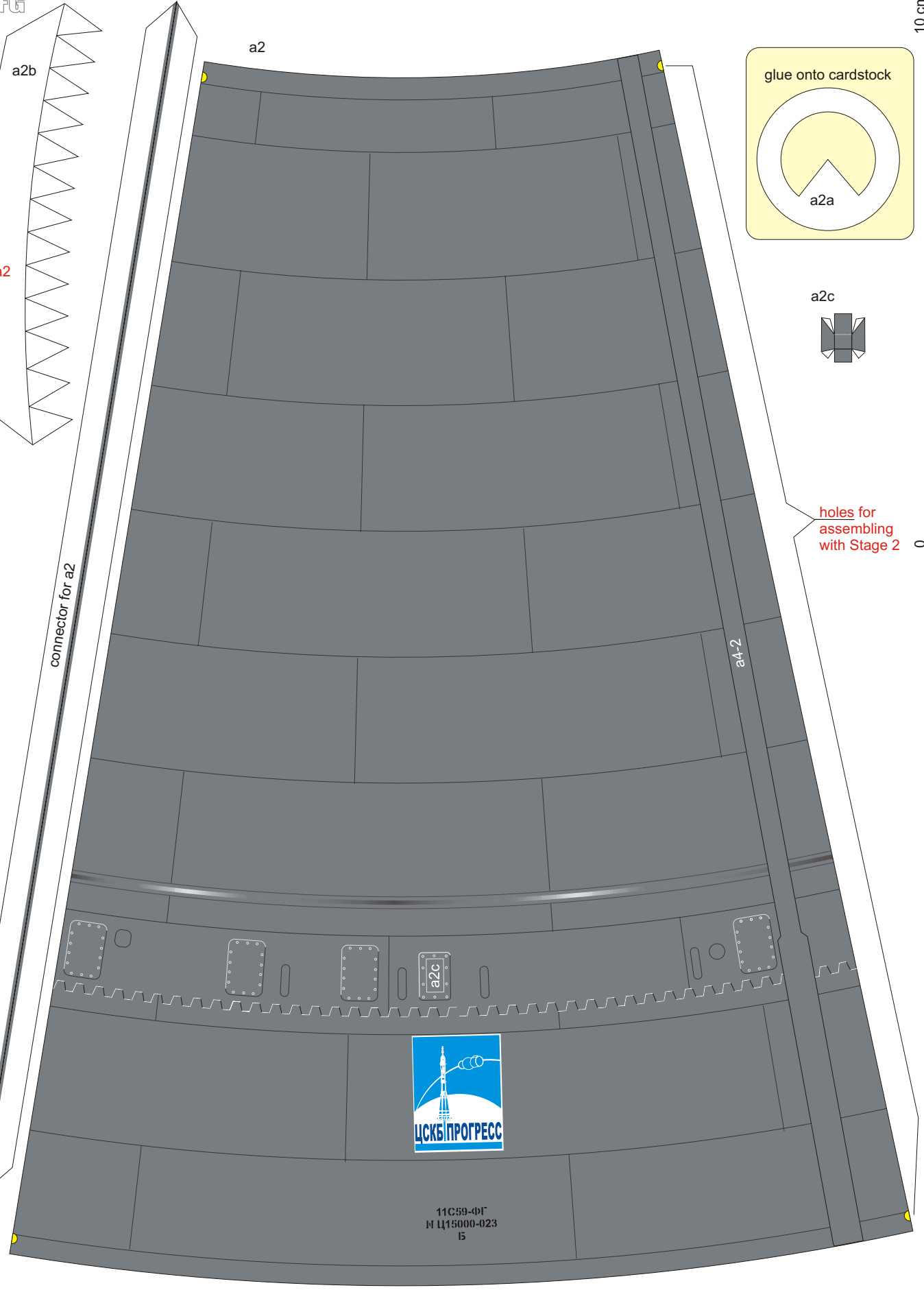

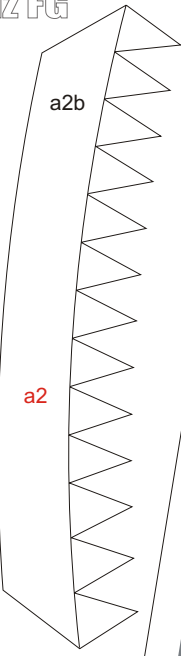
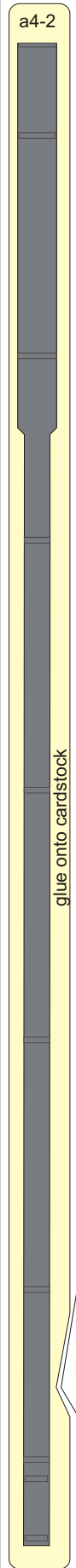

connector for a2

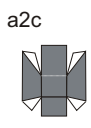
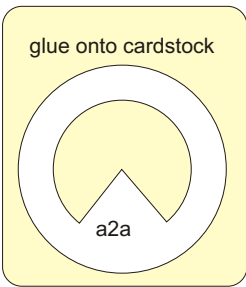
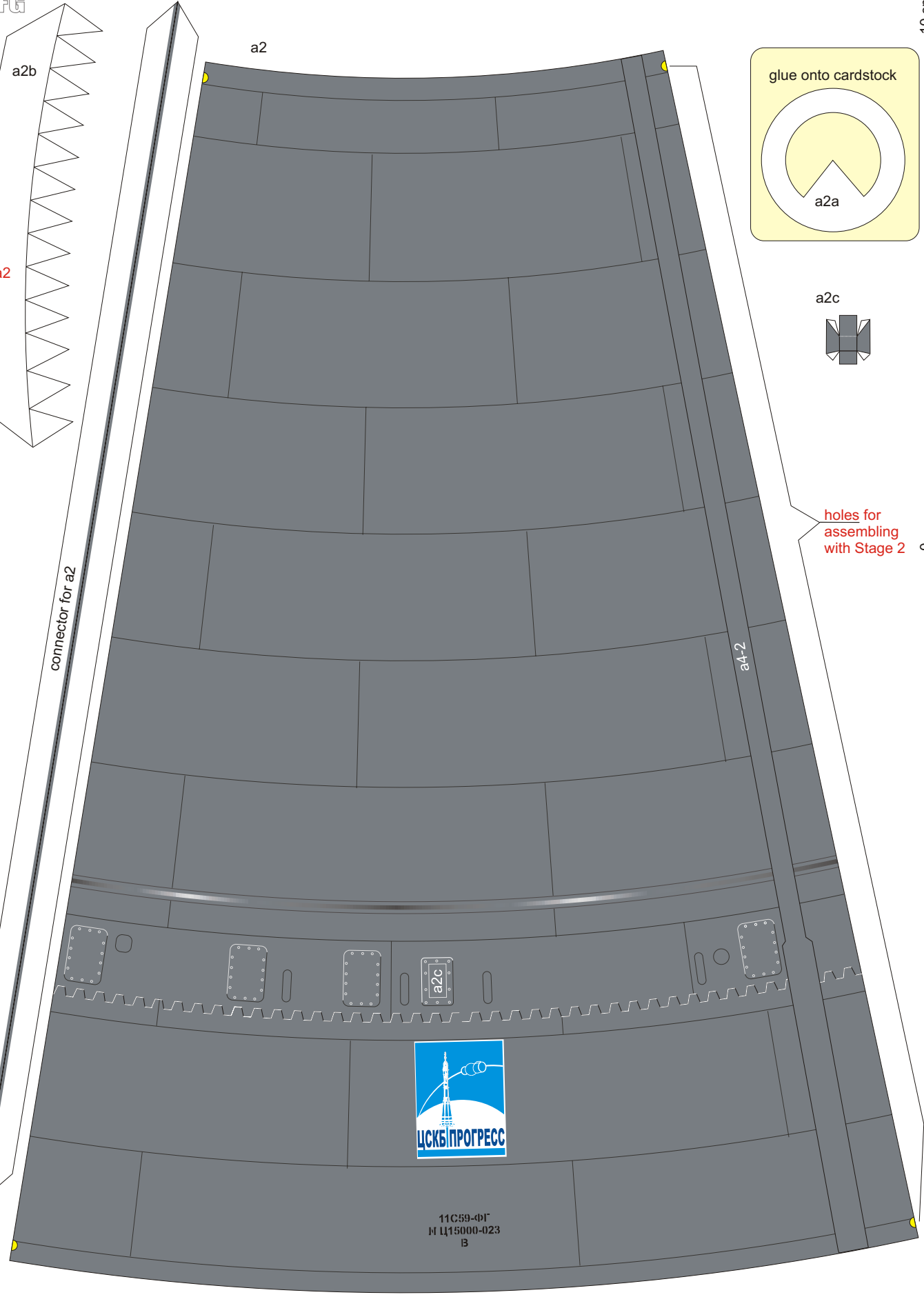

holes for assembling with Stage 2

a4-2



11С59-ФГ
И Ц15000-023
В

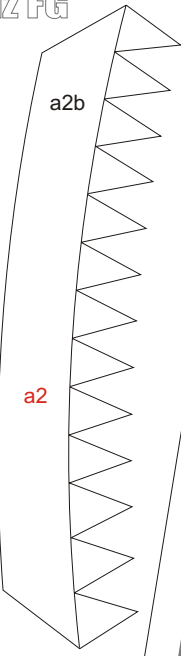
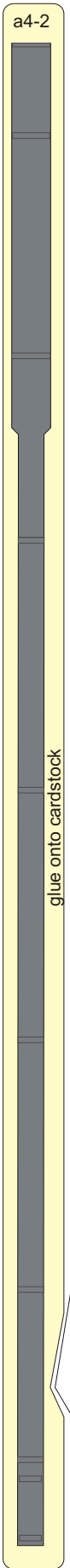

connector for a2

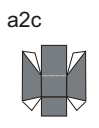
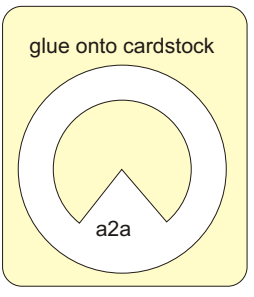

holes for assembling with Stage 2

0

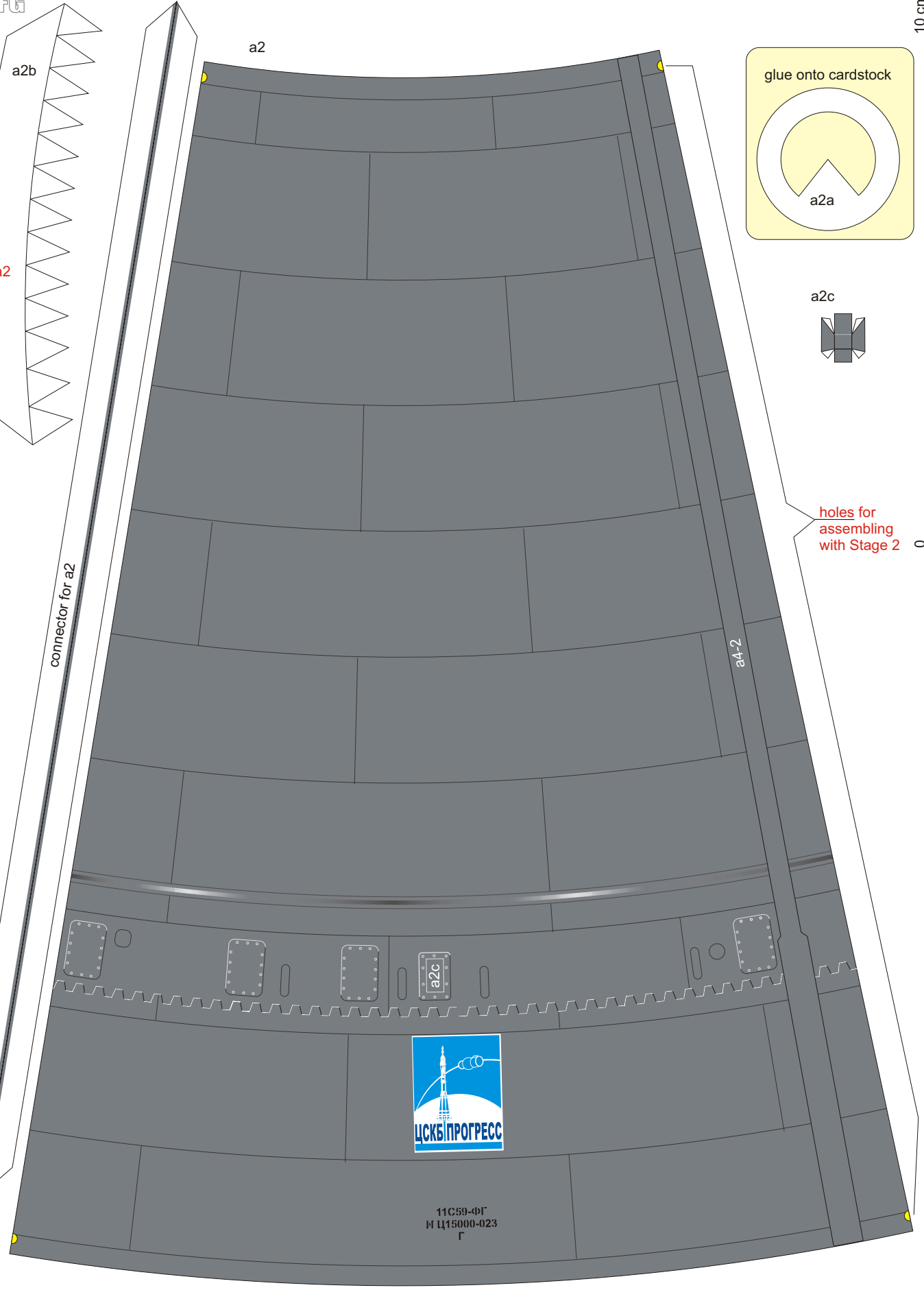

11С59-ФГ
И Ц15000-023
Г

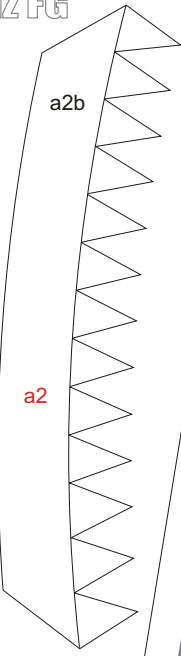
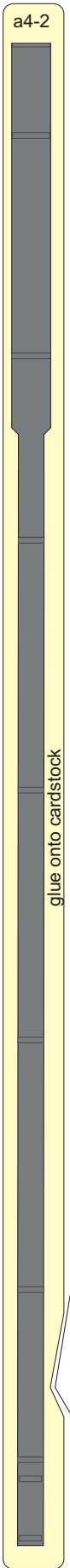

connector for a2

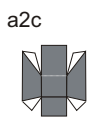
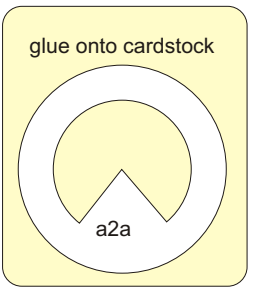

holes for assembling with Stage 2

0

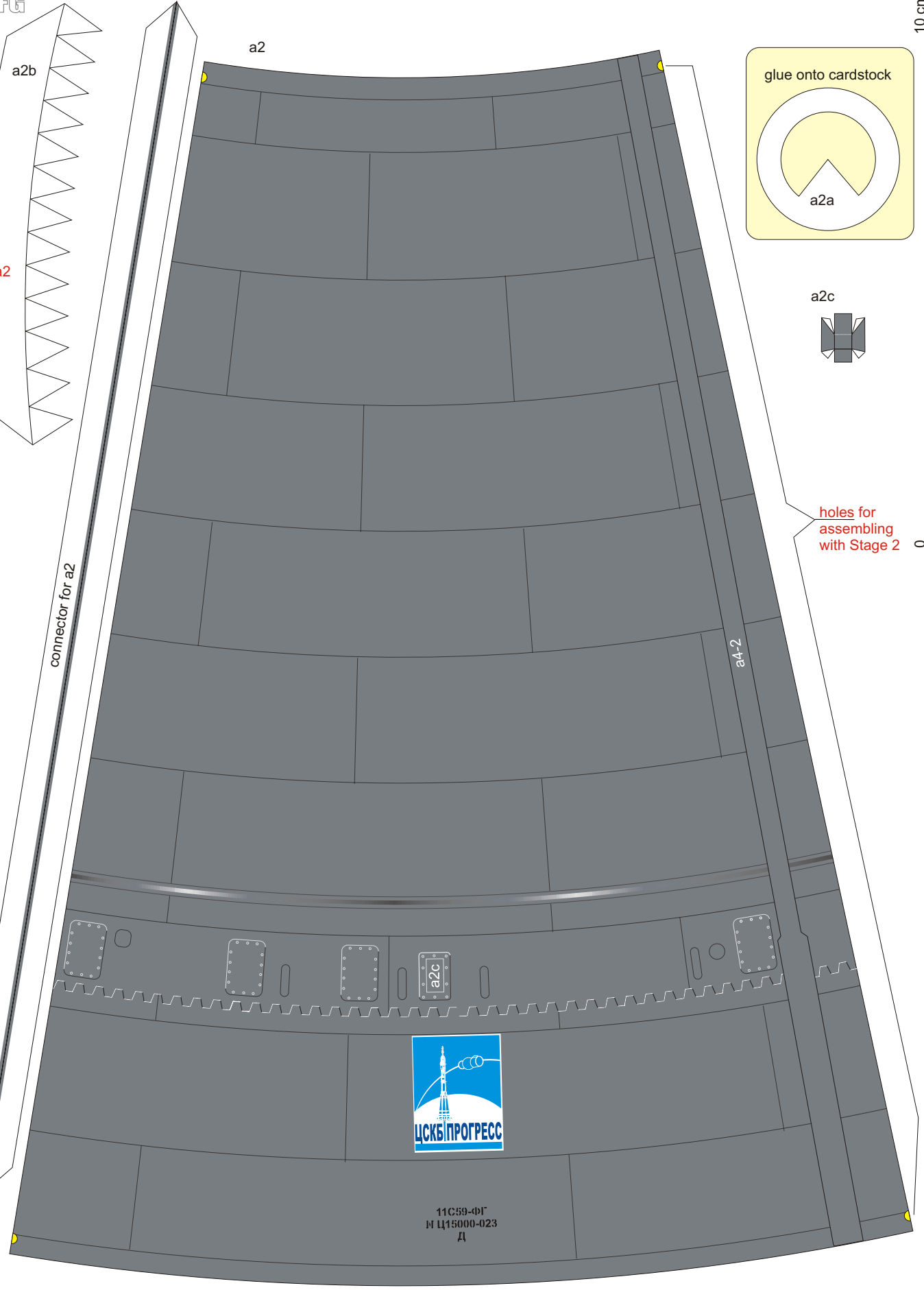

11С59-ФГ
И Ц15000-023
Д

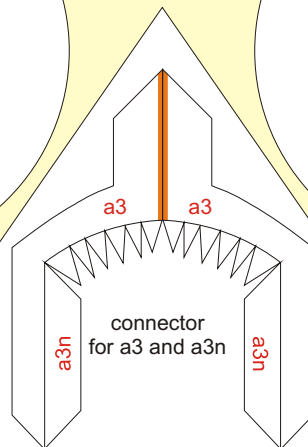
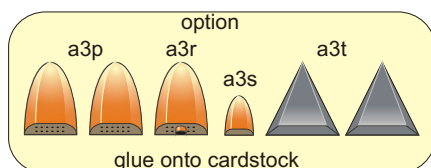
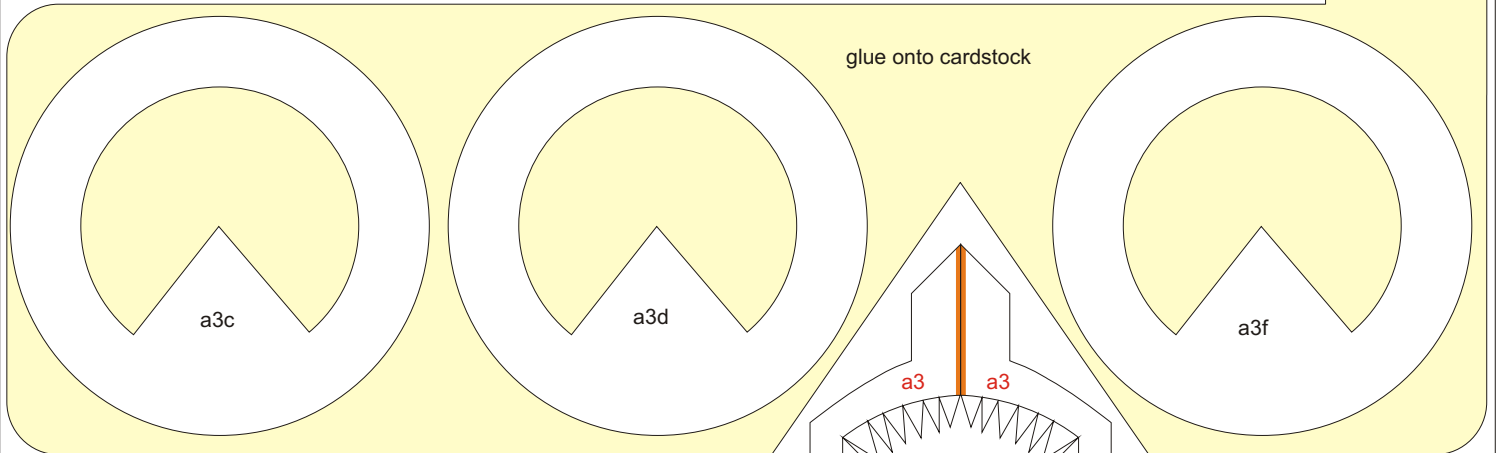
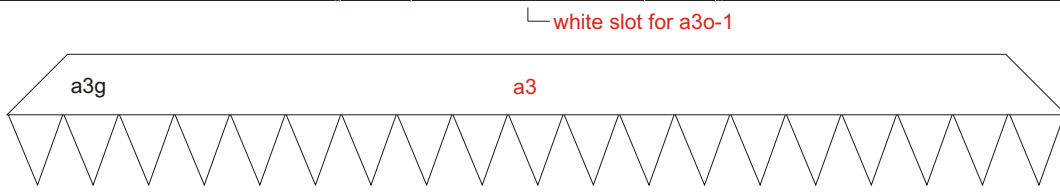
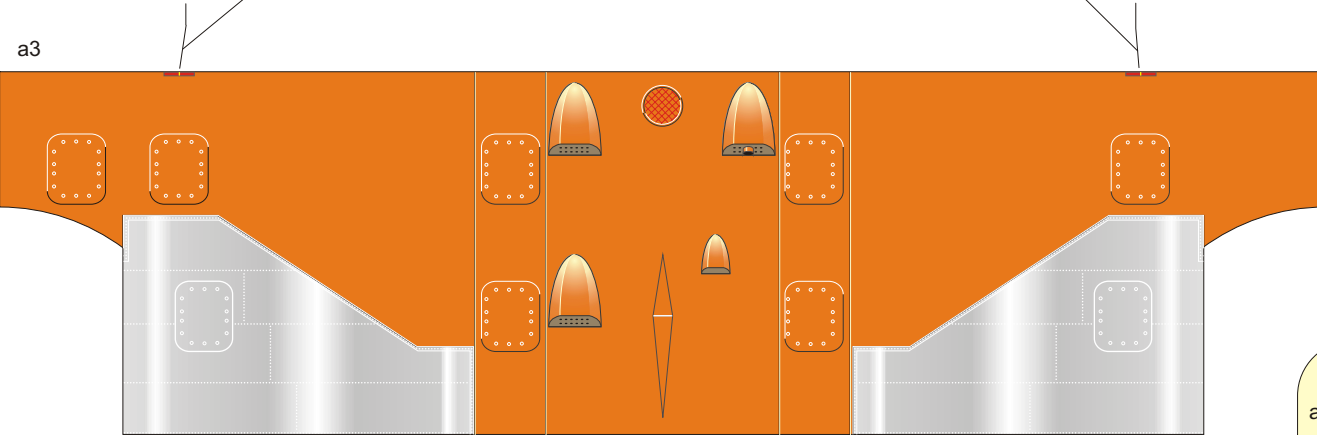
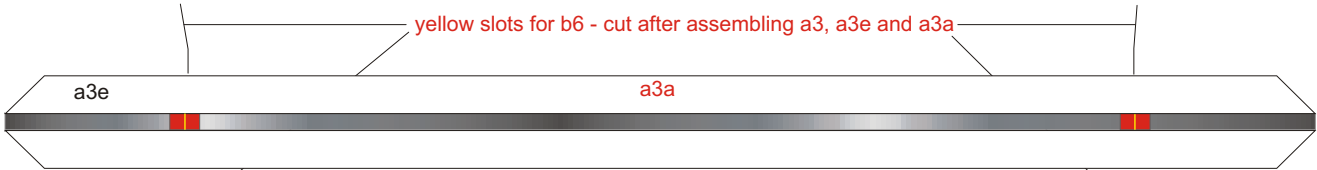
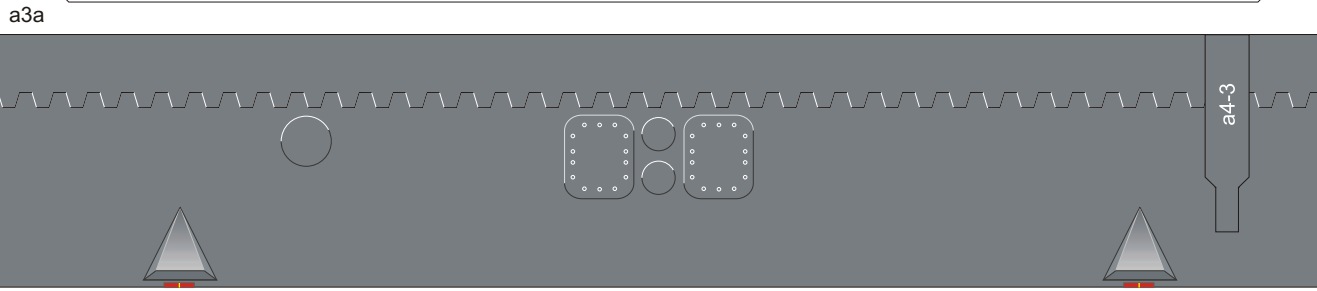
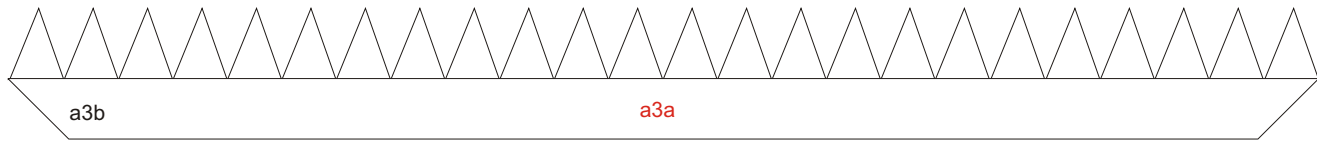

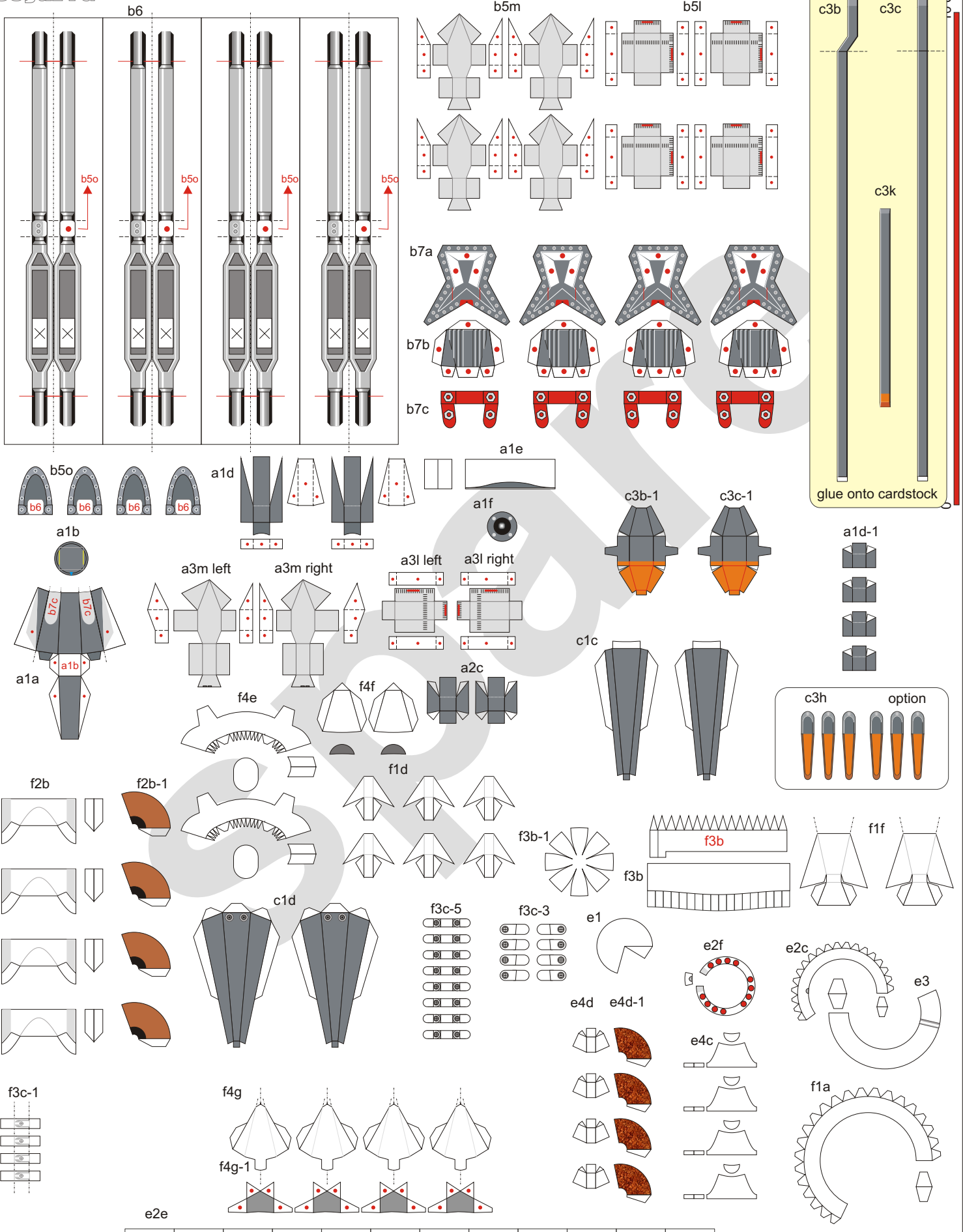

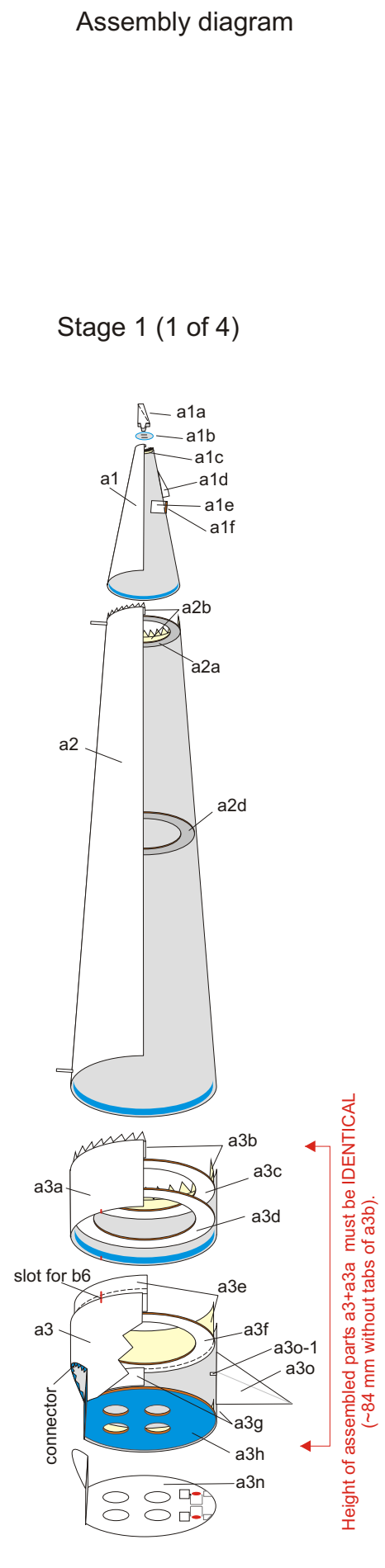
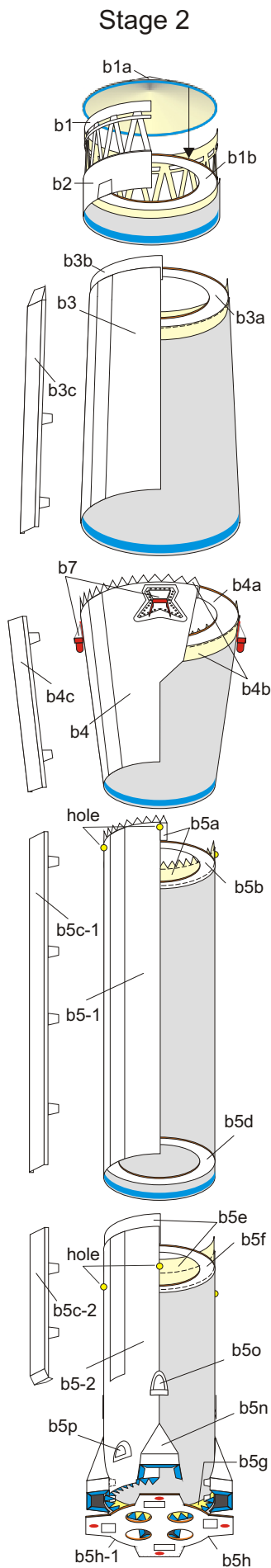
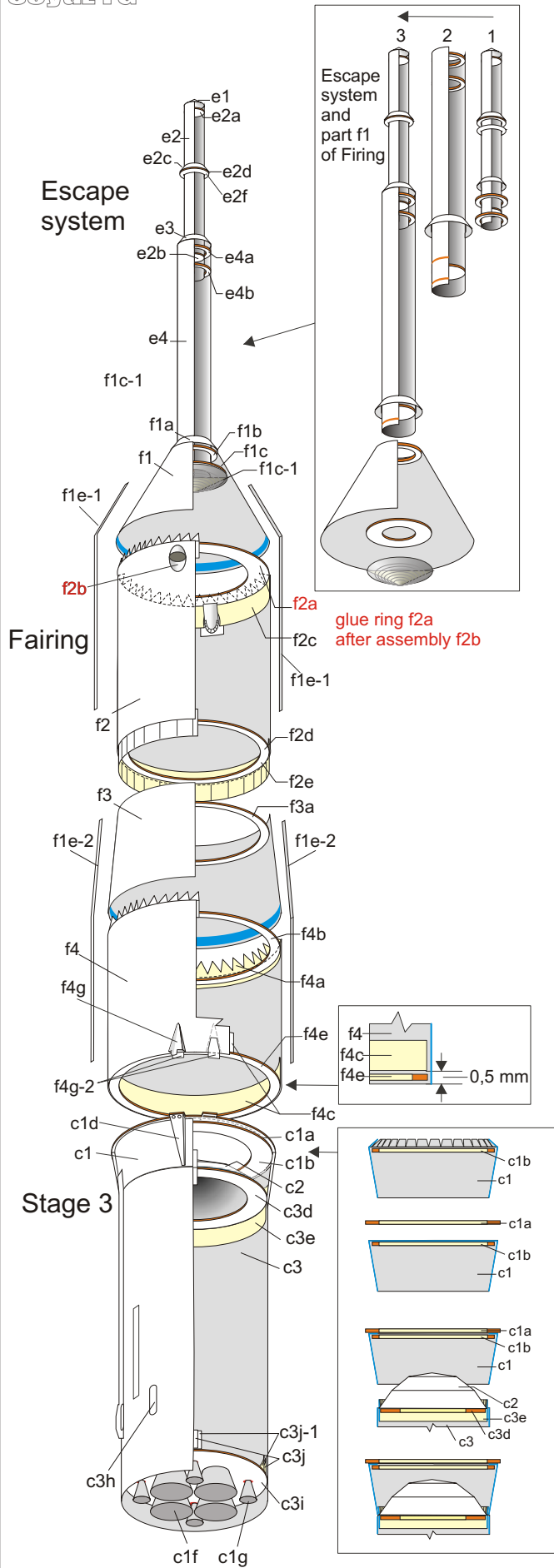

Assembling of Stages 1 and 2

