

[www.cardmodels-r.narod.ru](http://www.cardmodels-r.narod.ru)

# SOYUZ FG

1:48 scale

launcher

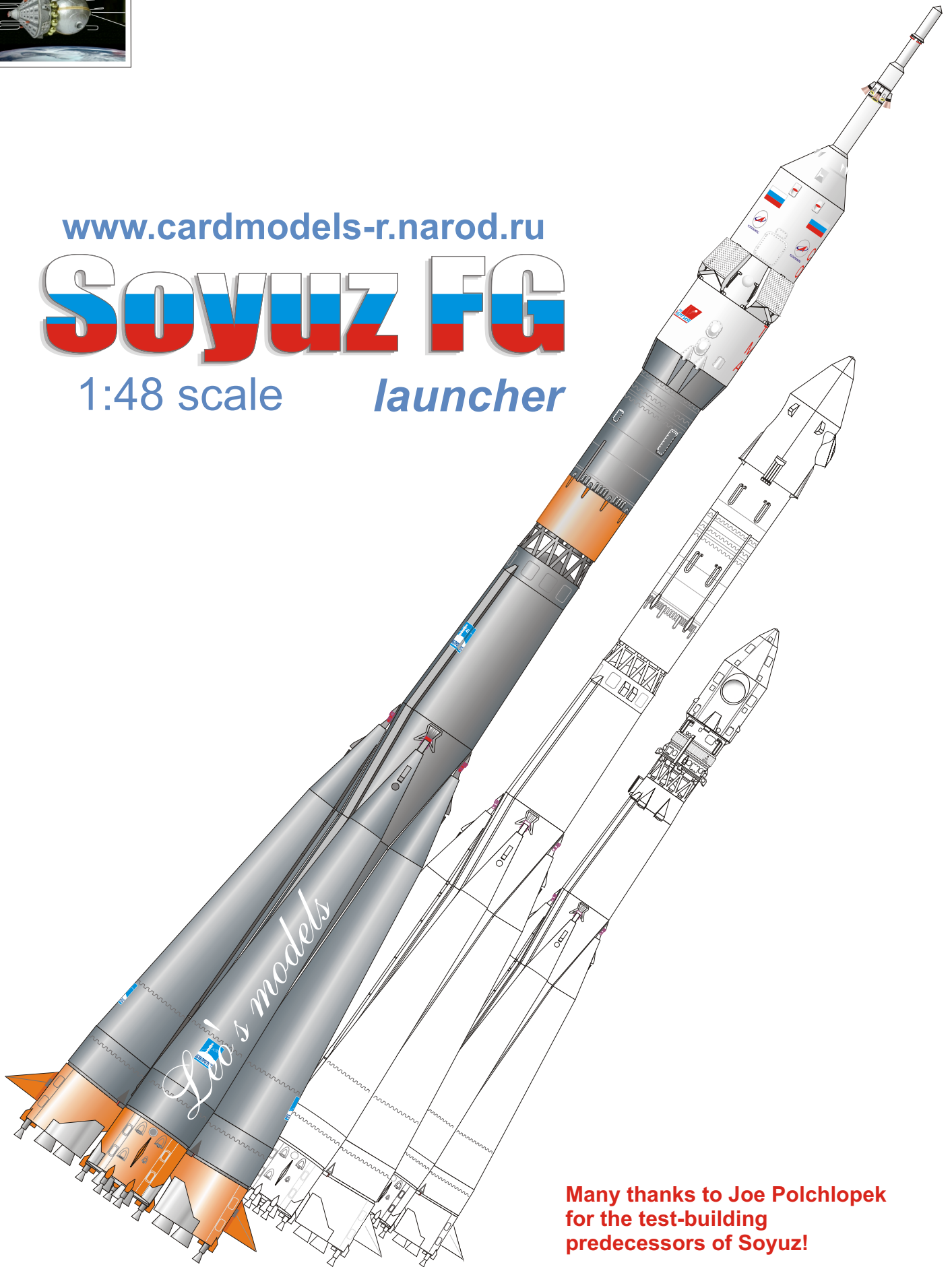

**Many thanks to Joe Polchlopek  
for the test-building  
predecessors of Soyuz!**

Fairing

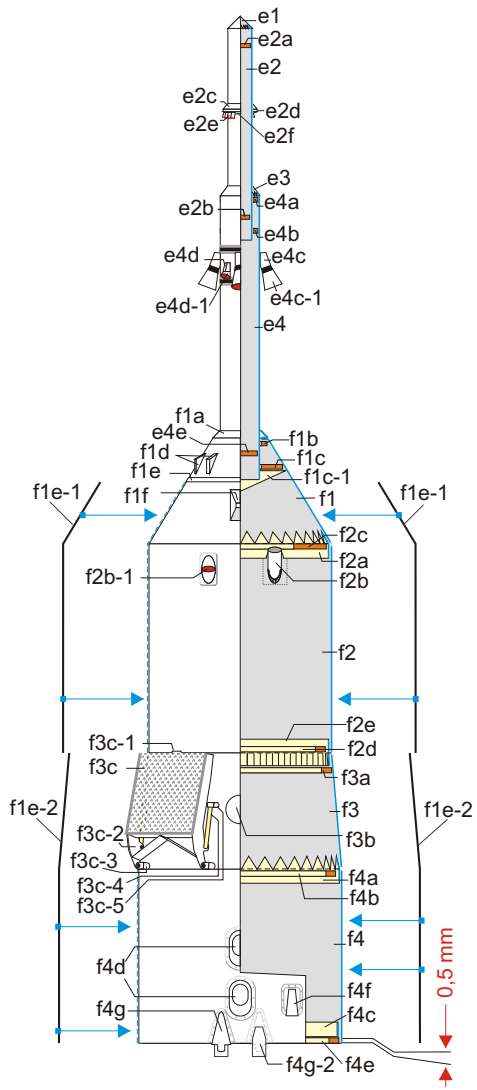

Stage 3

front view

back side view

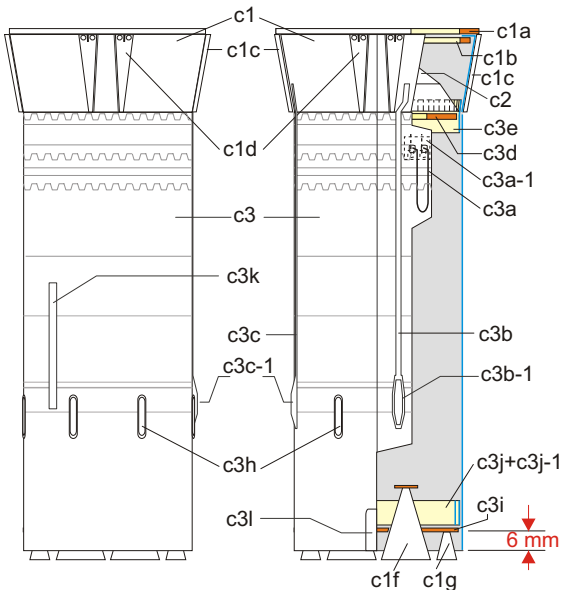

Paper used:  
 0,15 mm - 130 gr  
 0,26 mm - 200 gr ("cardstock")  
 Glue: PVA

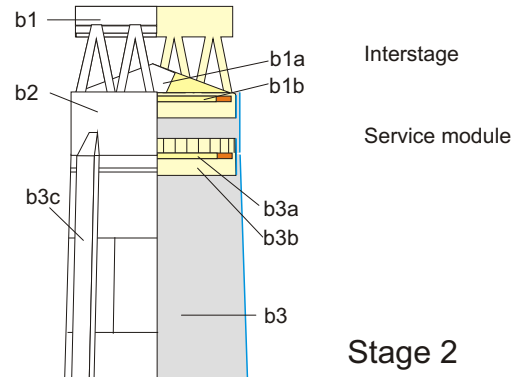

Stage 1

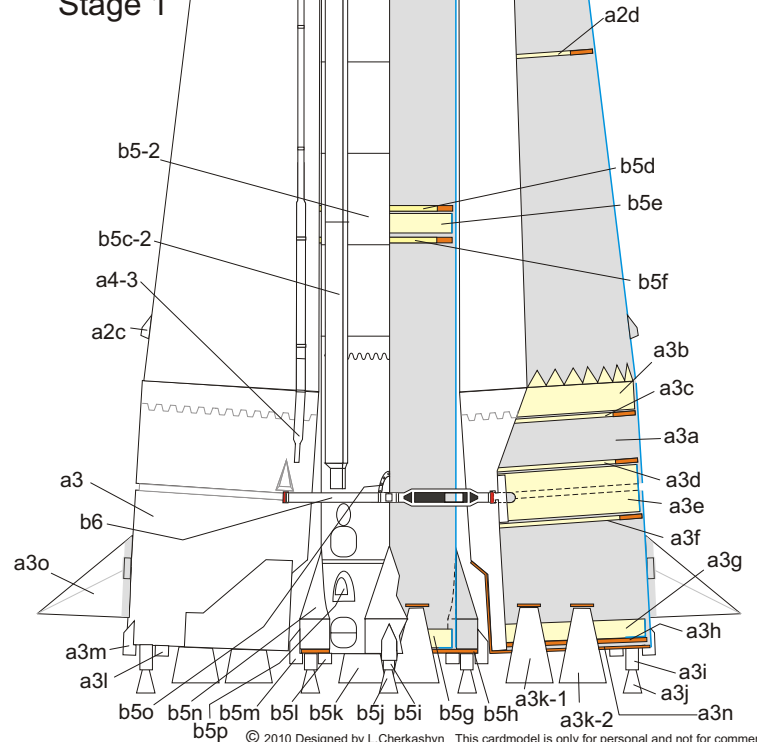

holes for assembling of Stage 1. Make ones only during assembling!

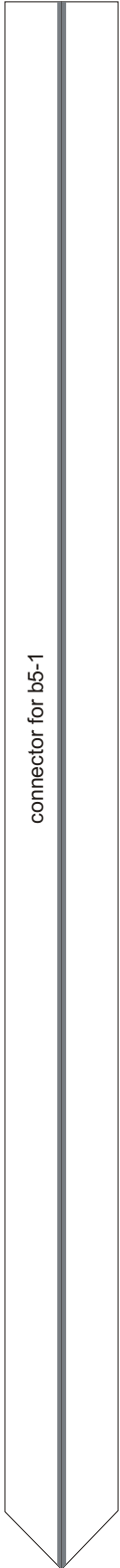

connector for b5-1

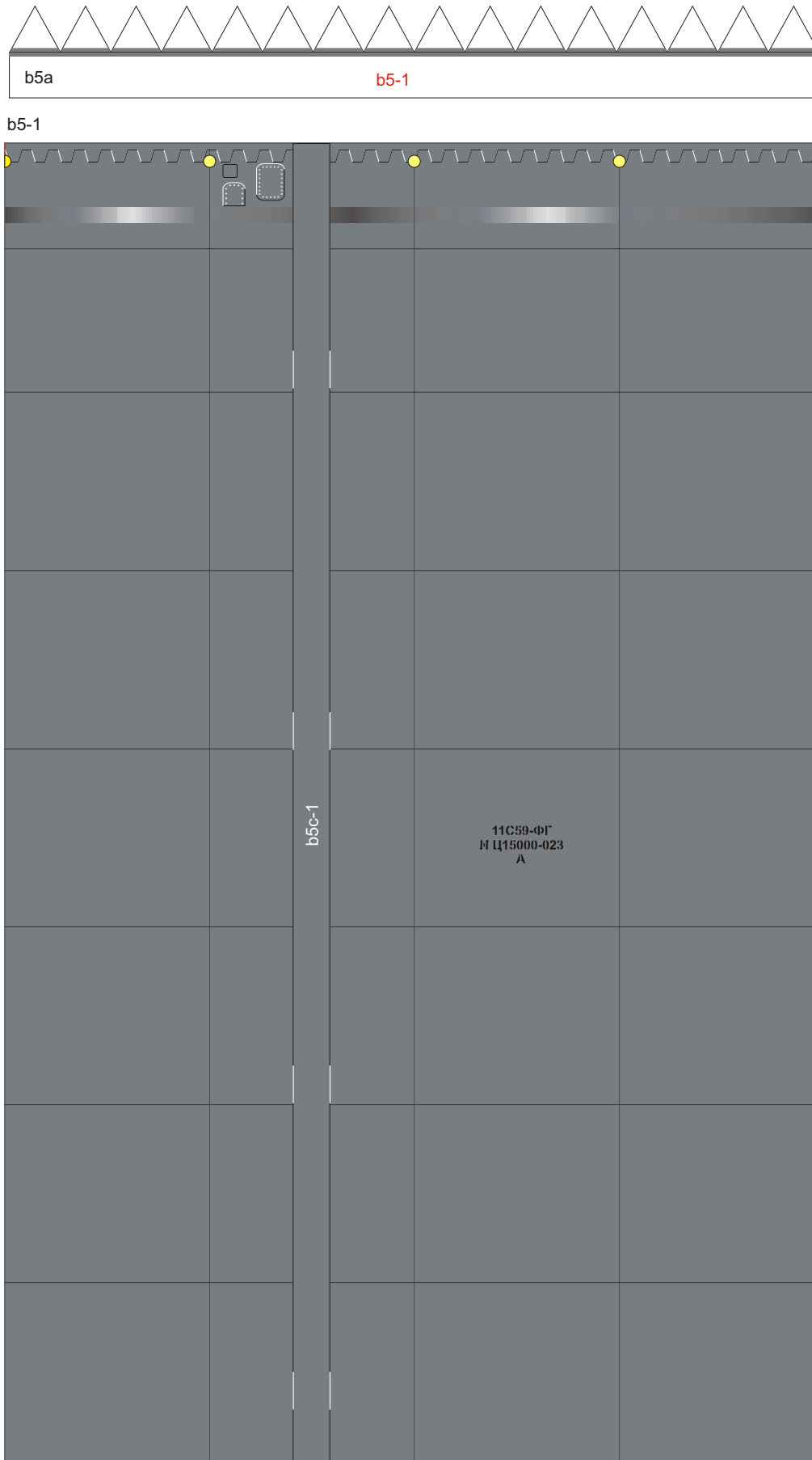

white slots for b5c-1



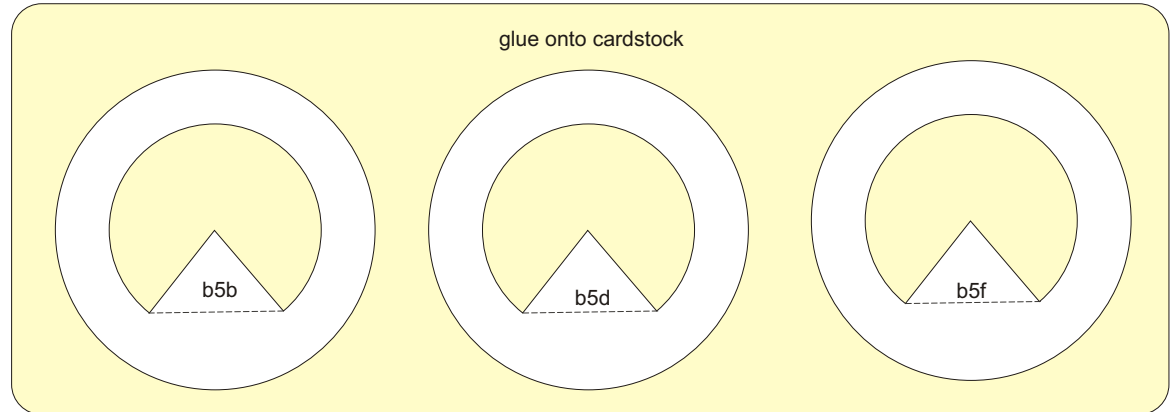
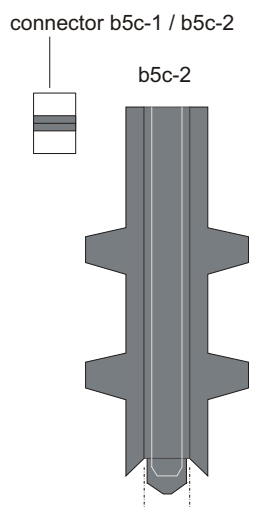
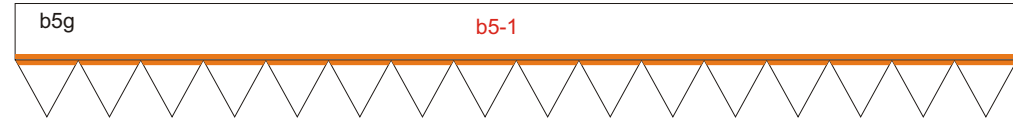
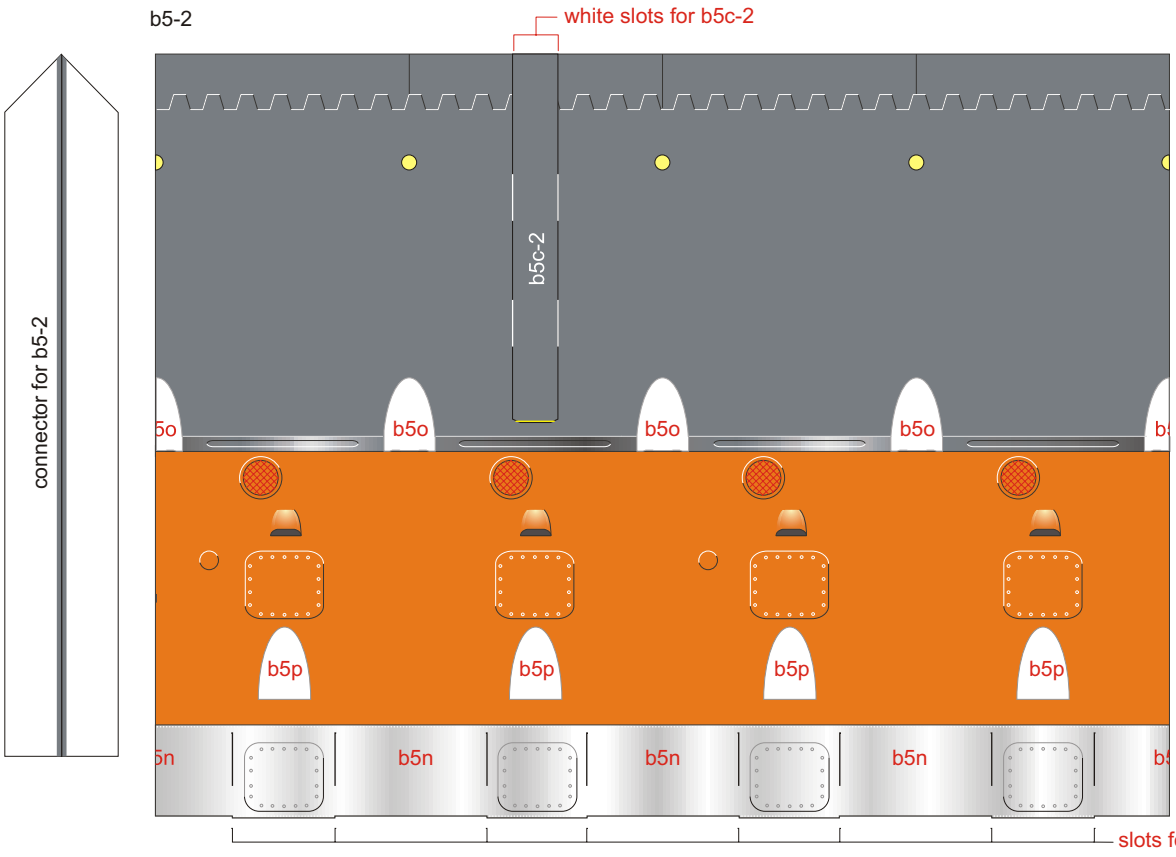
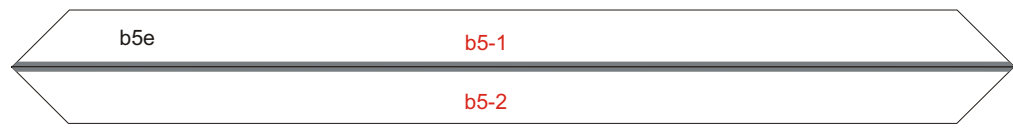

Internal parts of nozzles b5j and b5k



ends of b6 for inserting to Stage 1

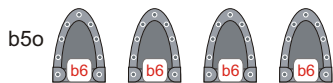
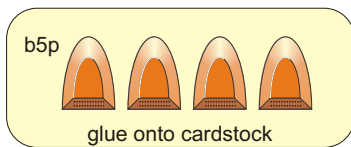
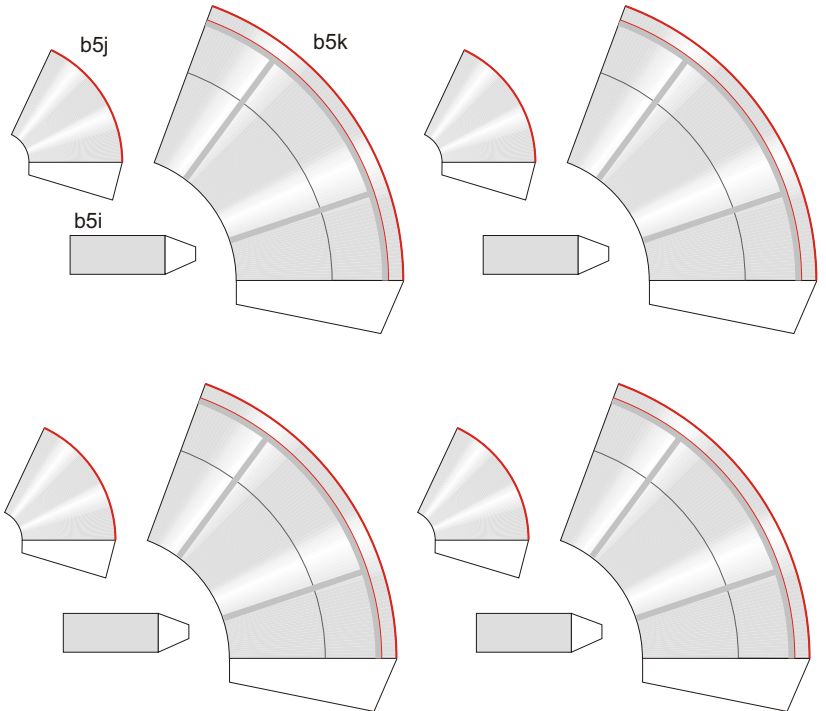
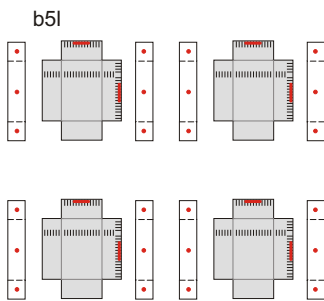
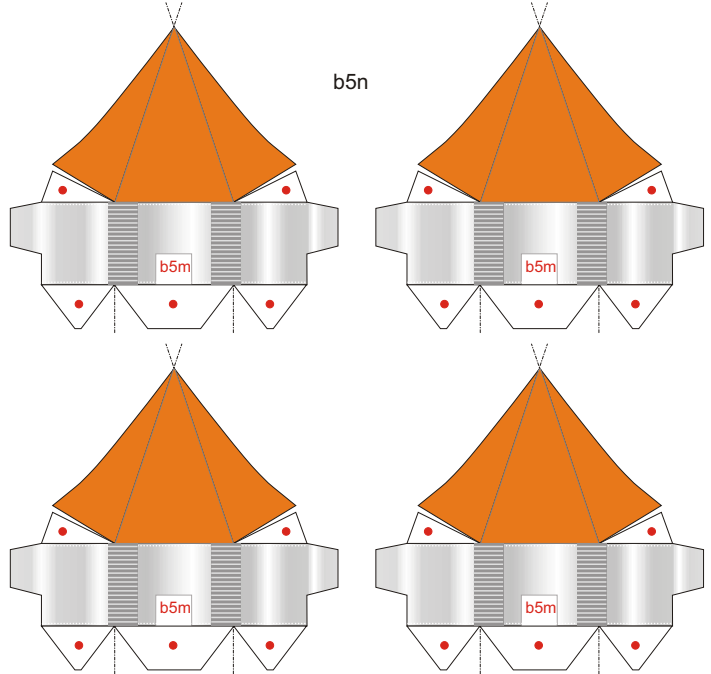
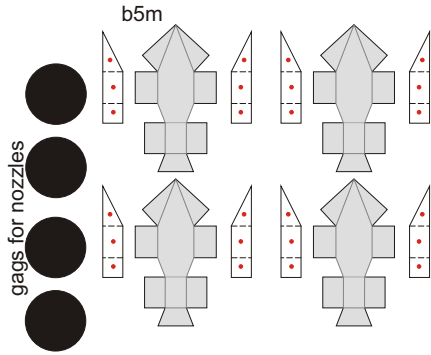
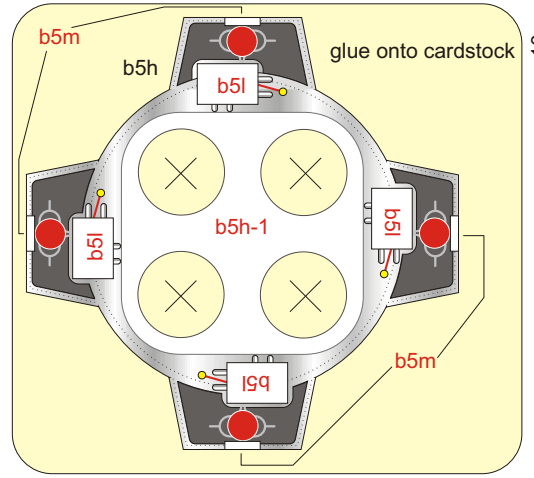
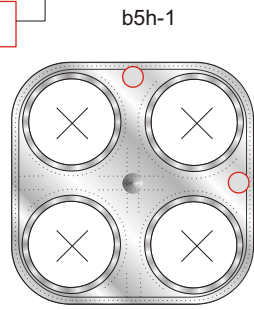
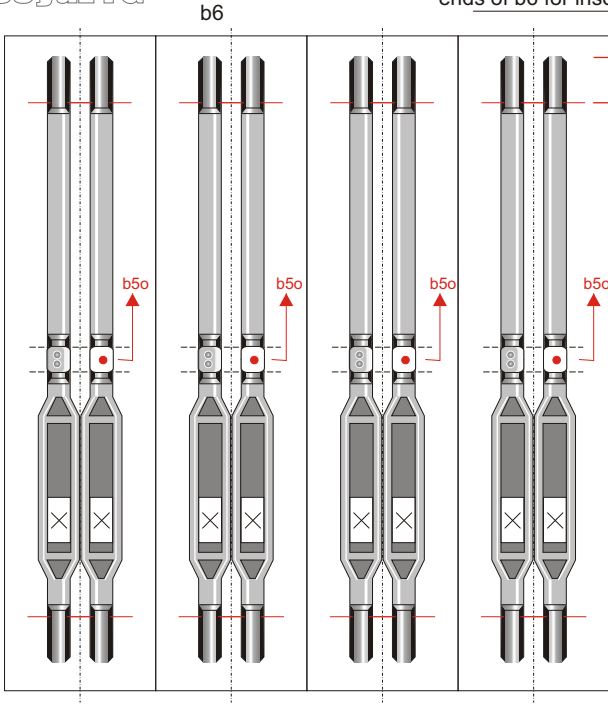

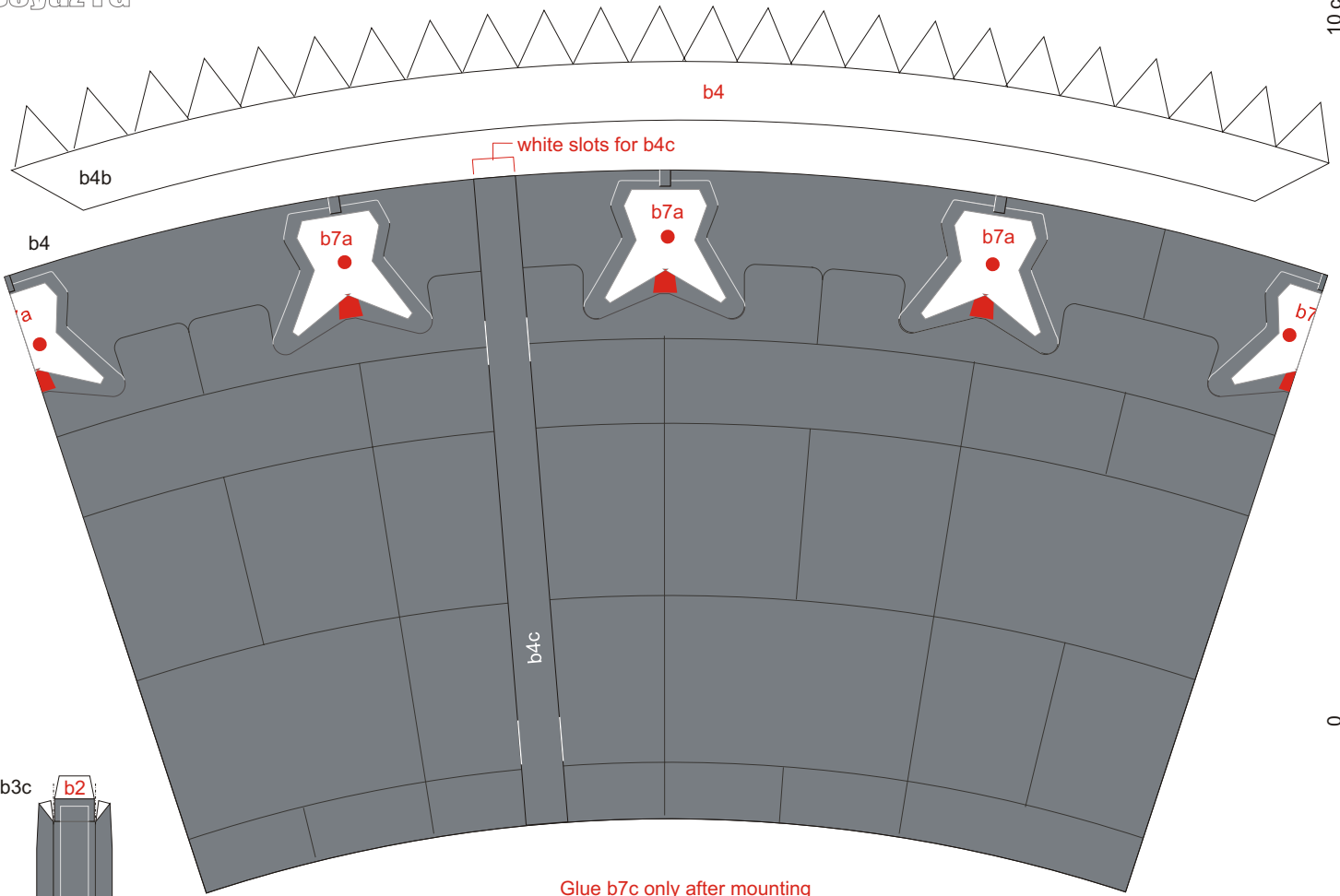

Glue b7c only after mounting blocks of stage 1 onto stage 2 !

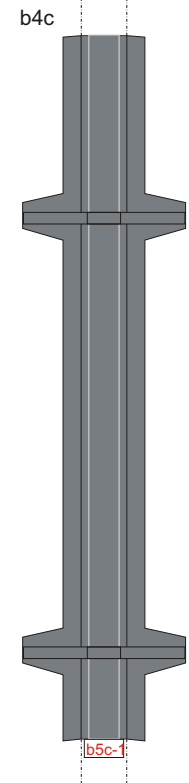
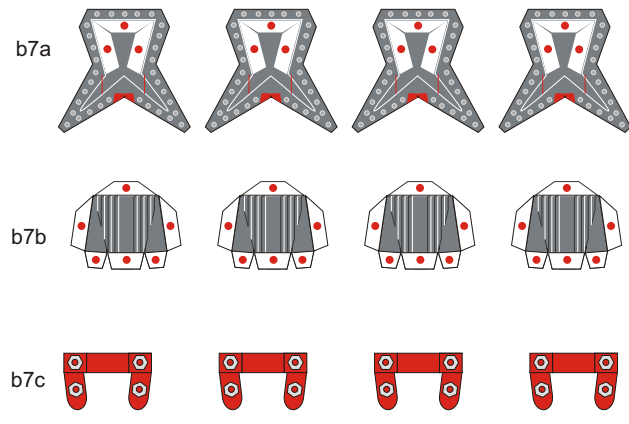
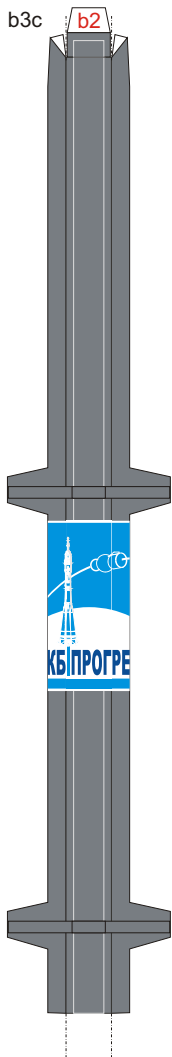
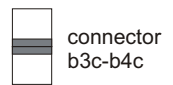
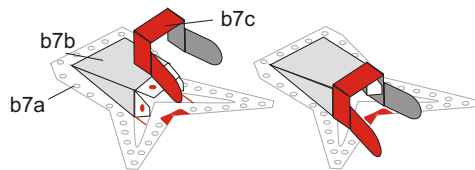

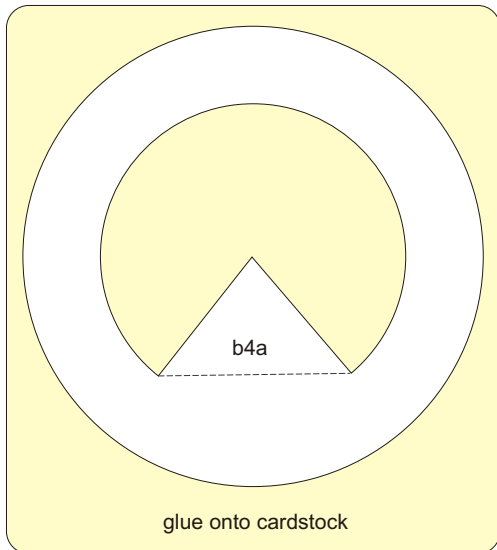
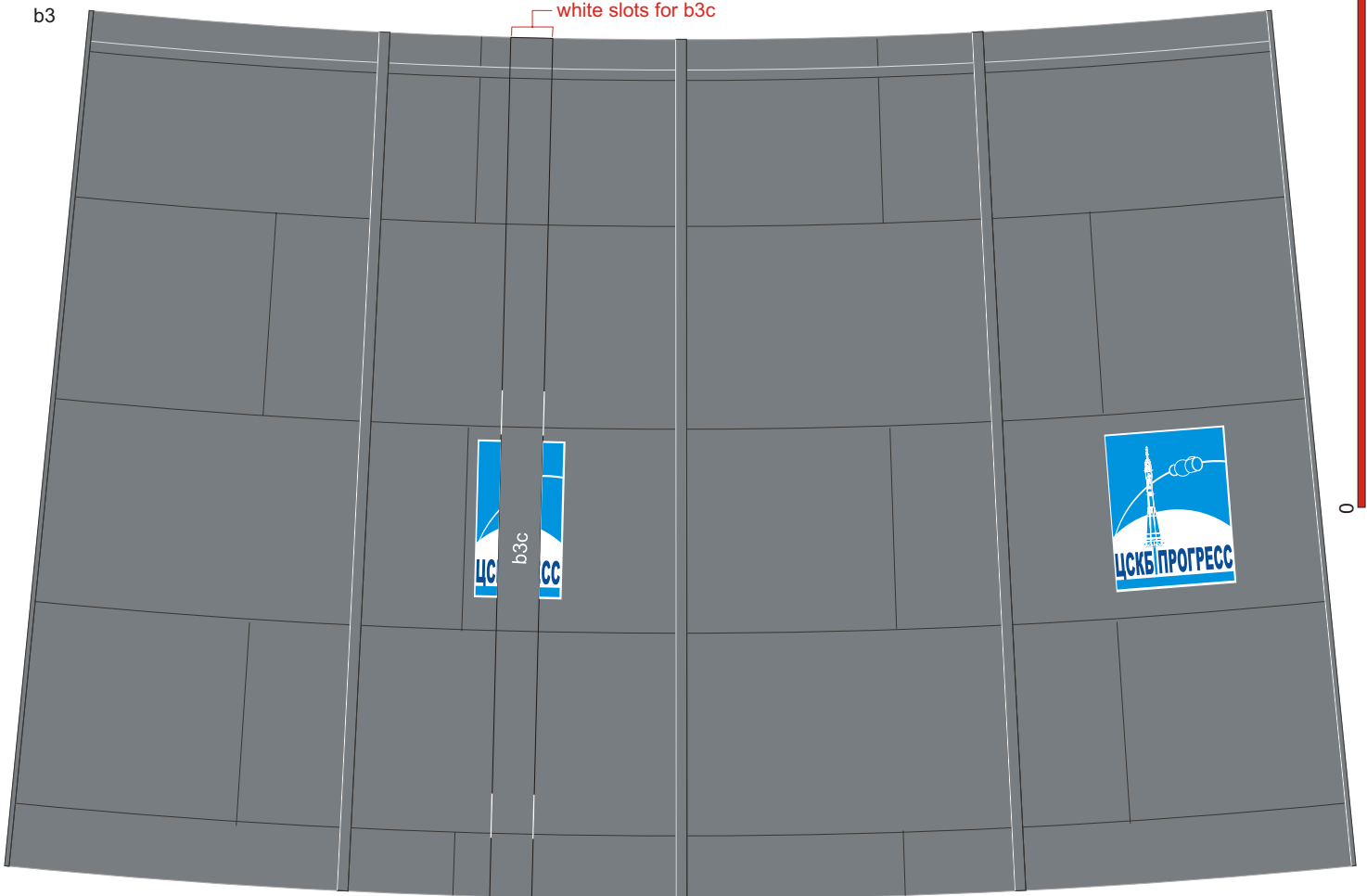
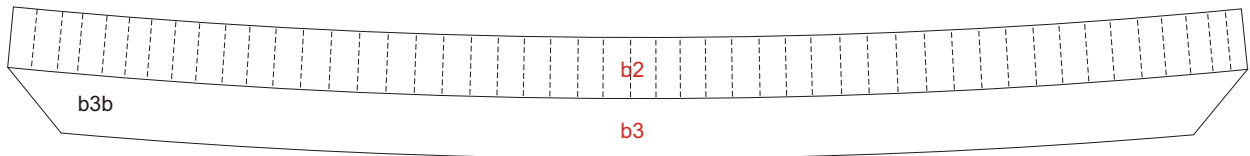

Internal parts of nozzles c1f and c1g

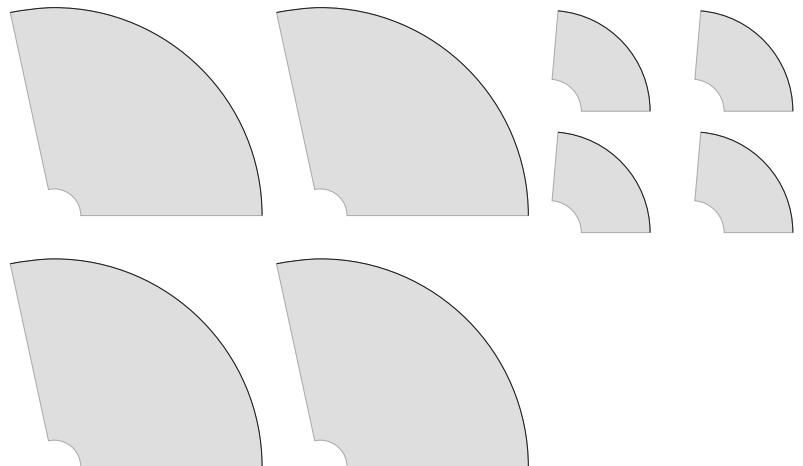

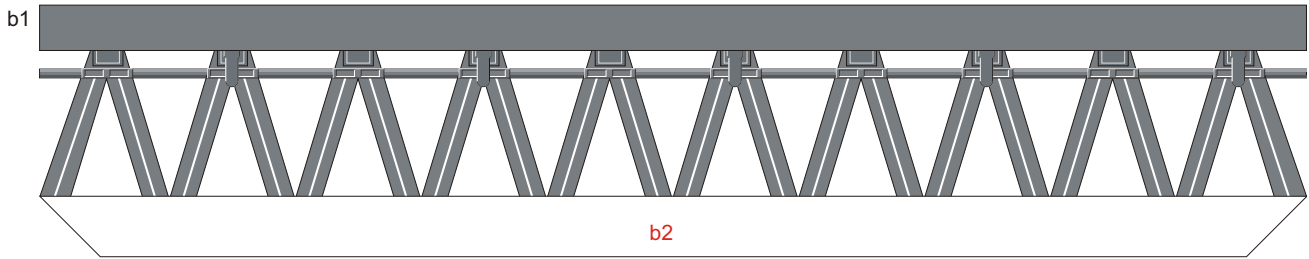

glue onto back side of part b1 before cut one

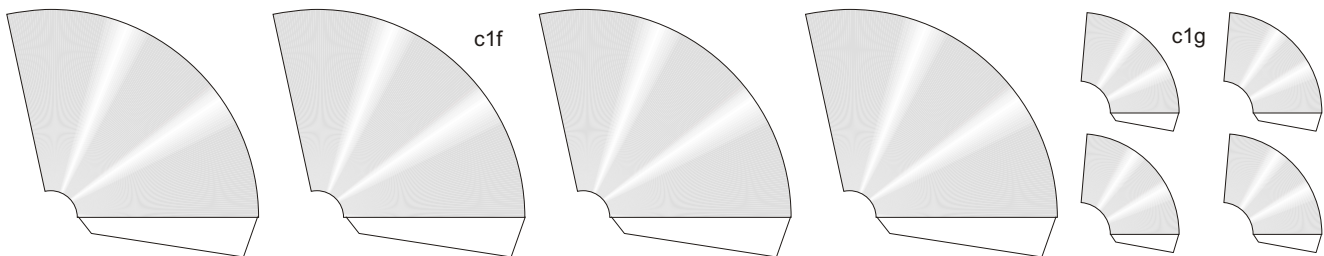
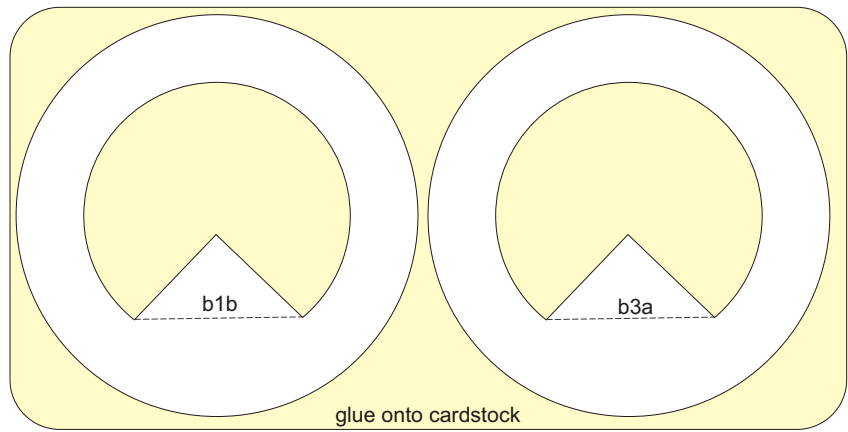
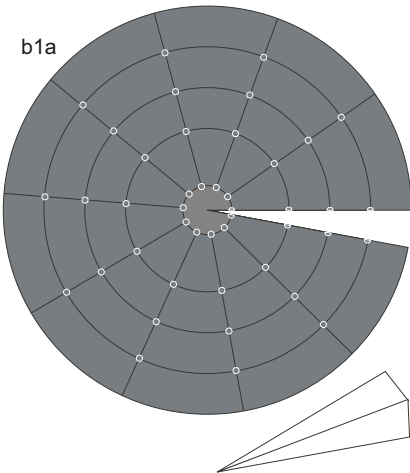
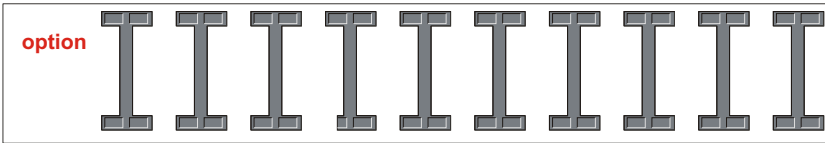
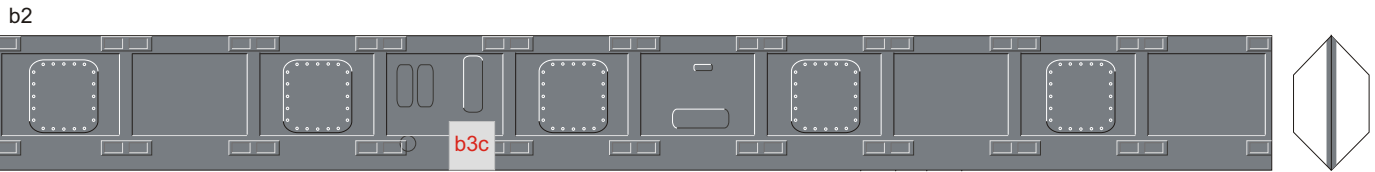



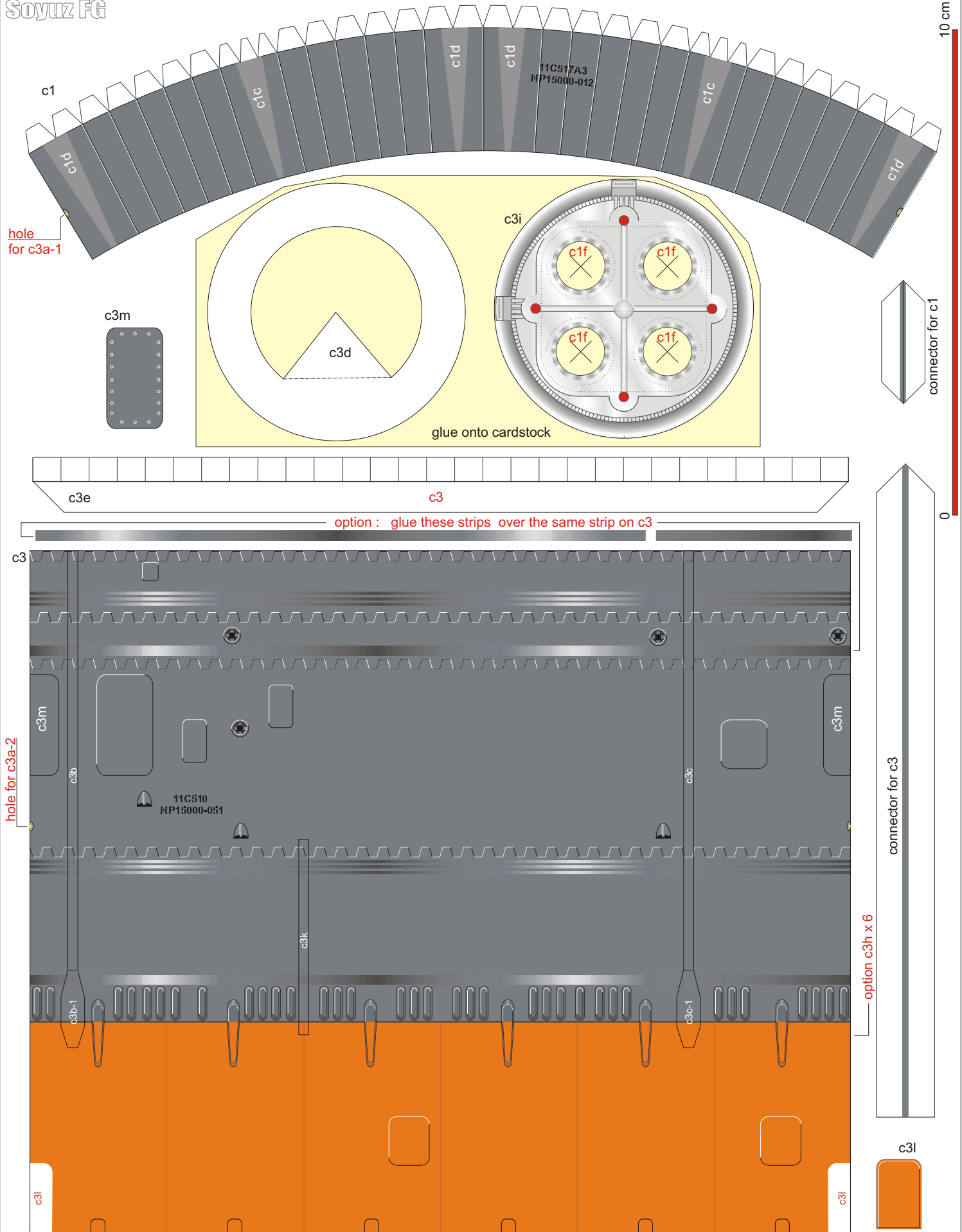

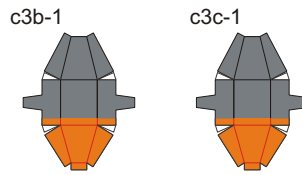
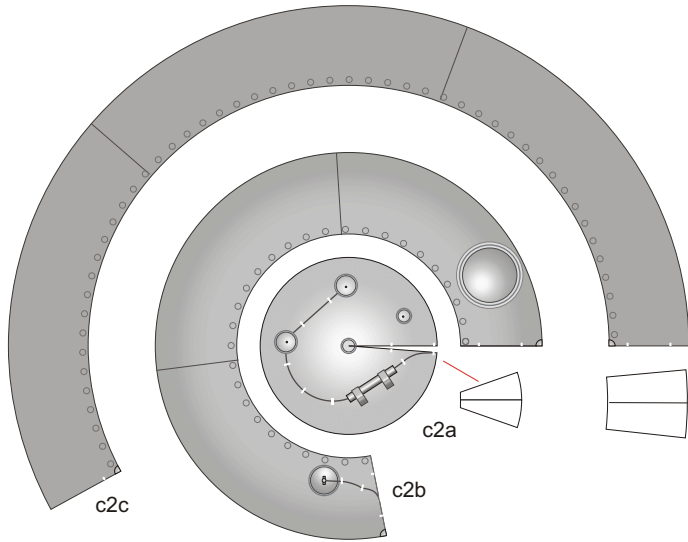
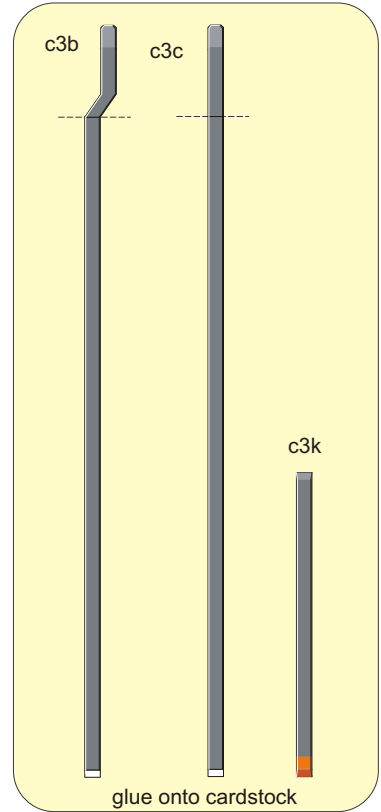
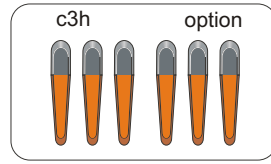
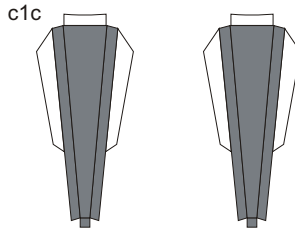
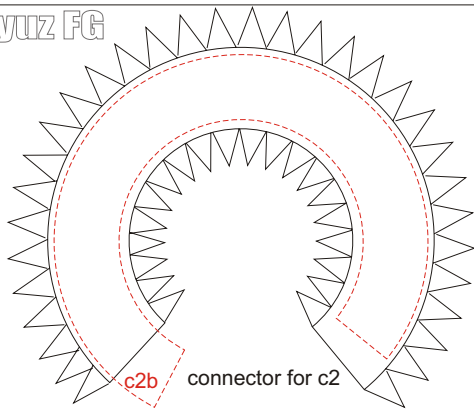

"silver" wire d~0,5 mm

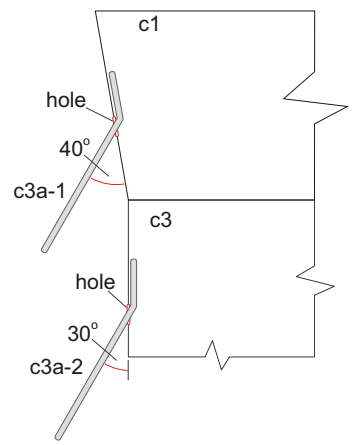
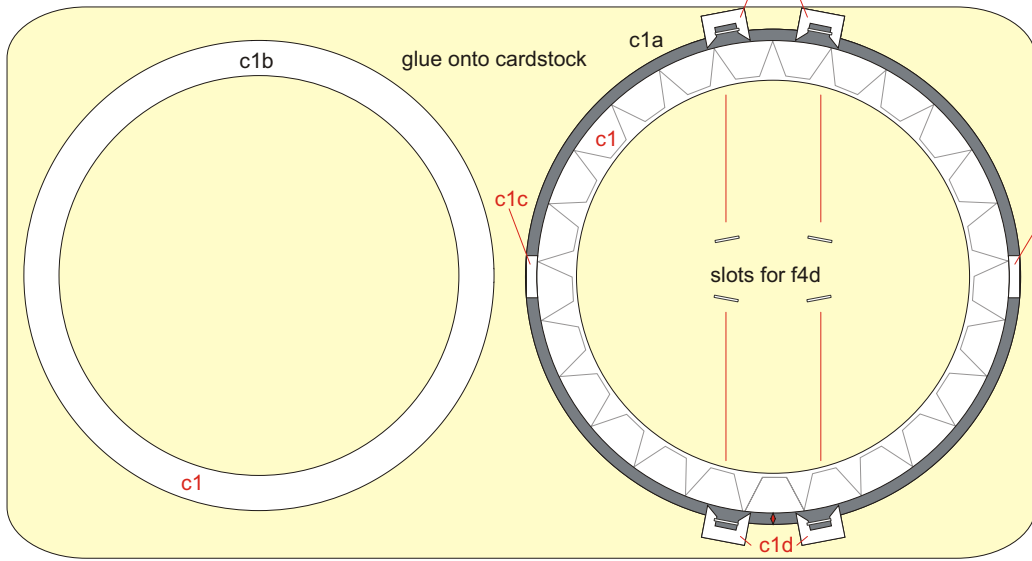
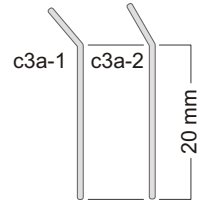

c3j	c3
supports fo c3i	
c3j-1	c3j

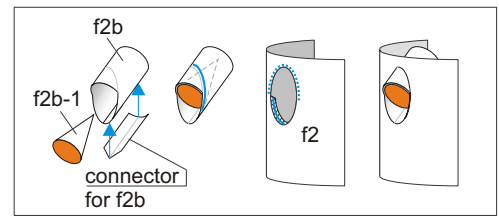
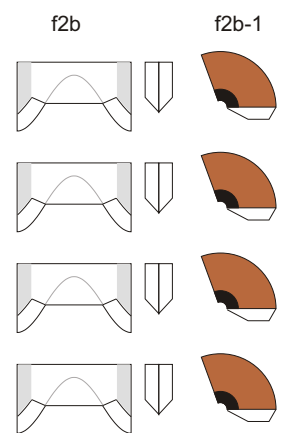
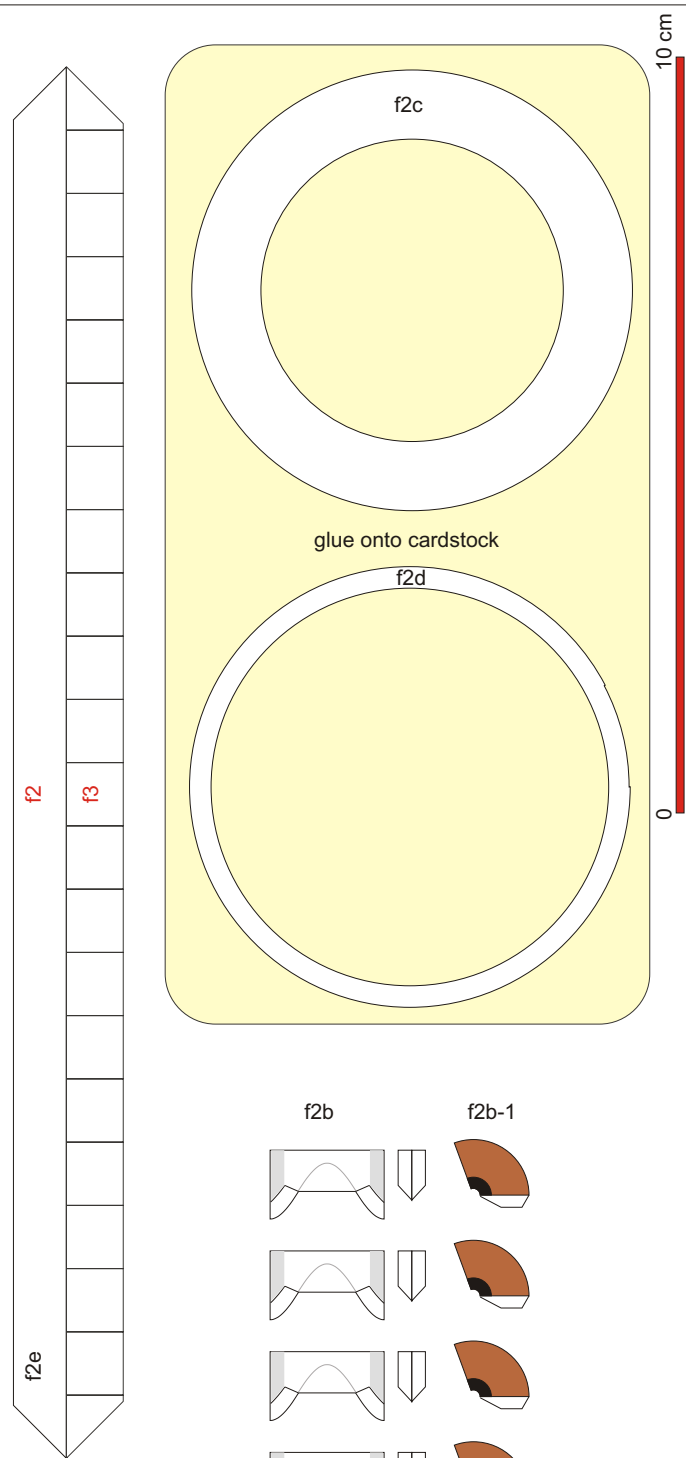
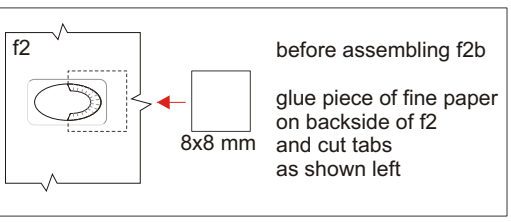
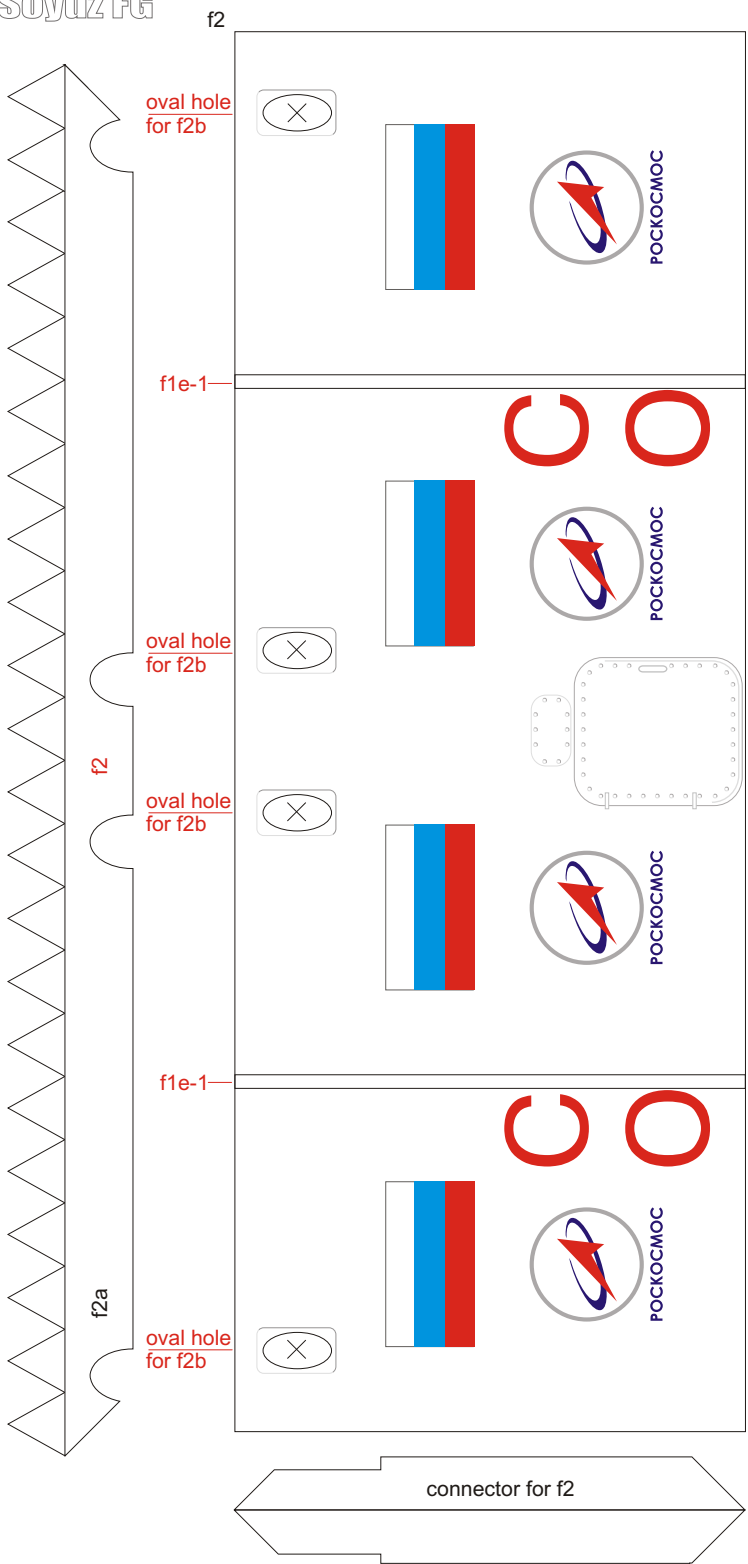

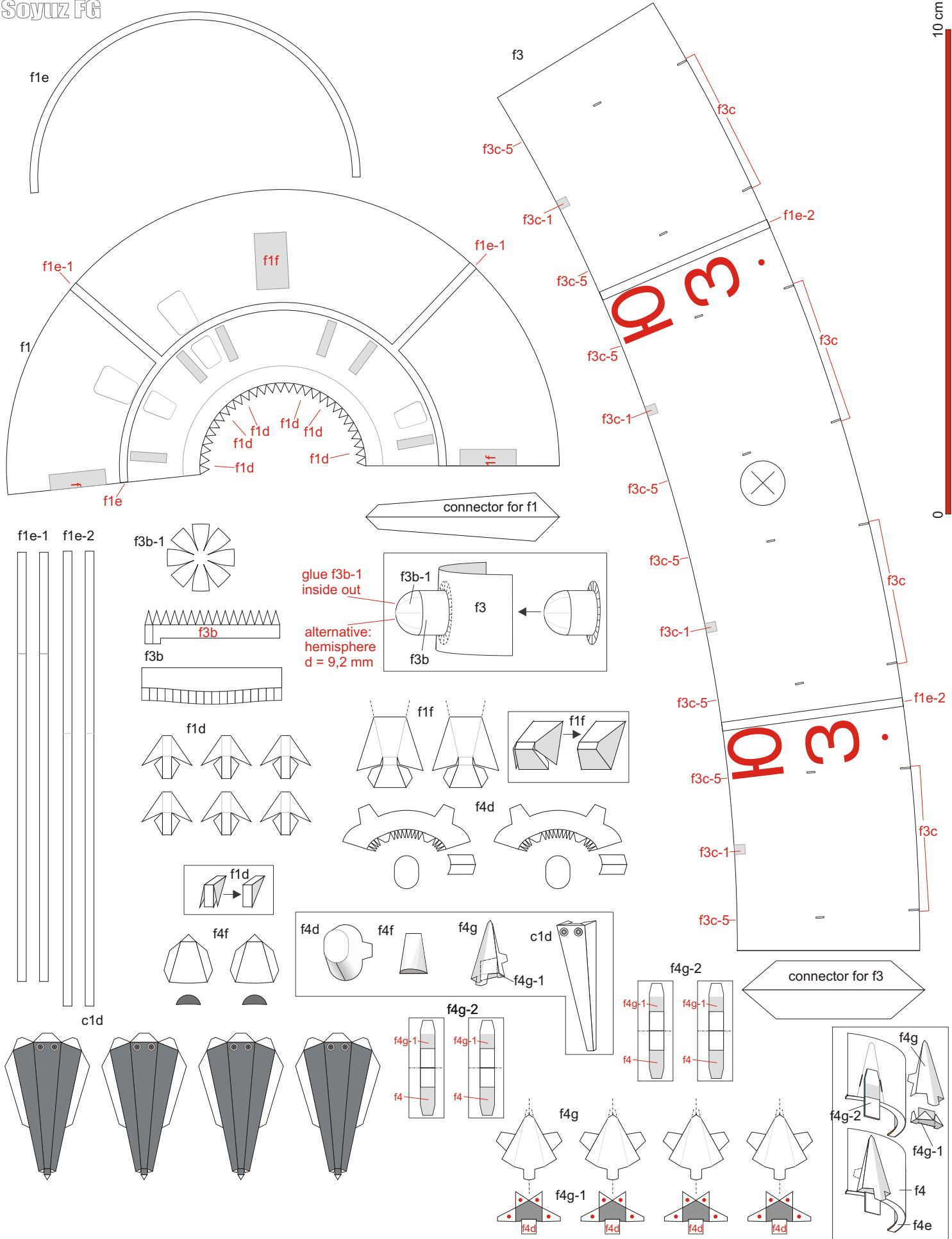

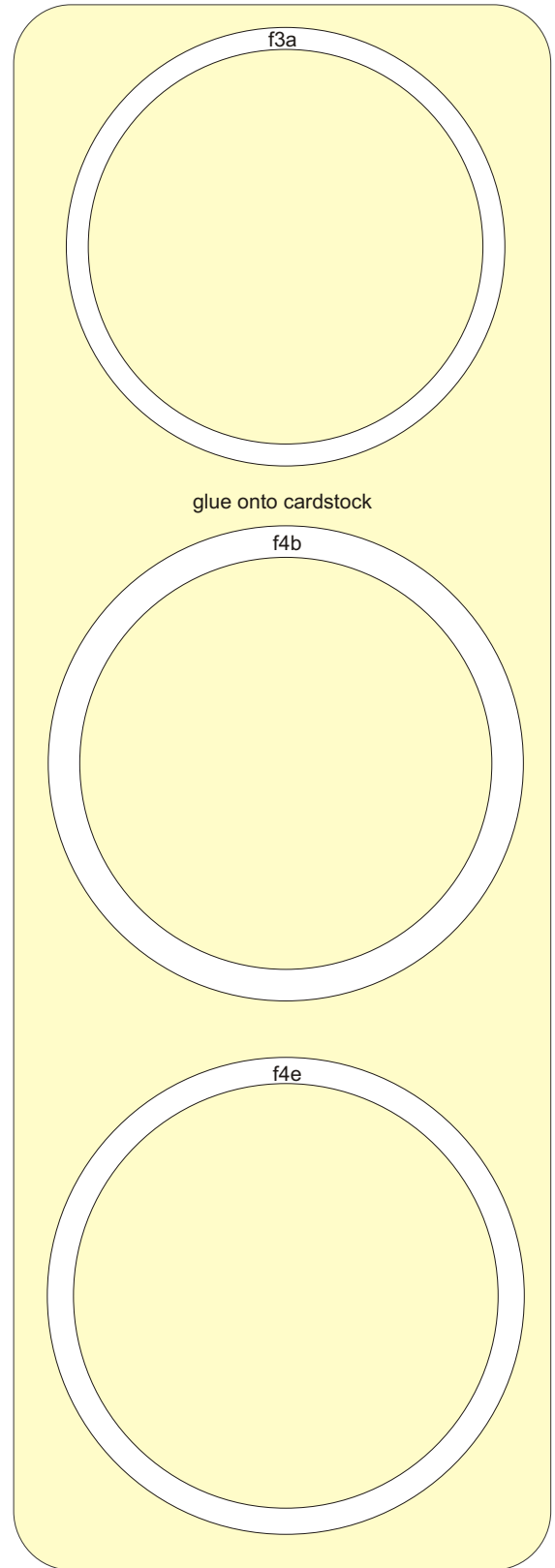
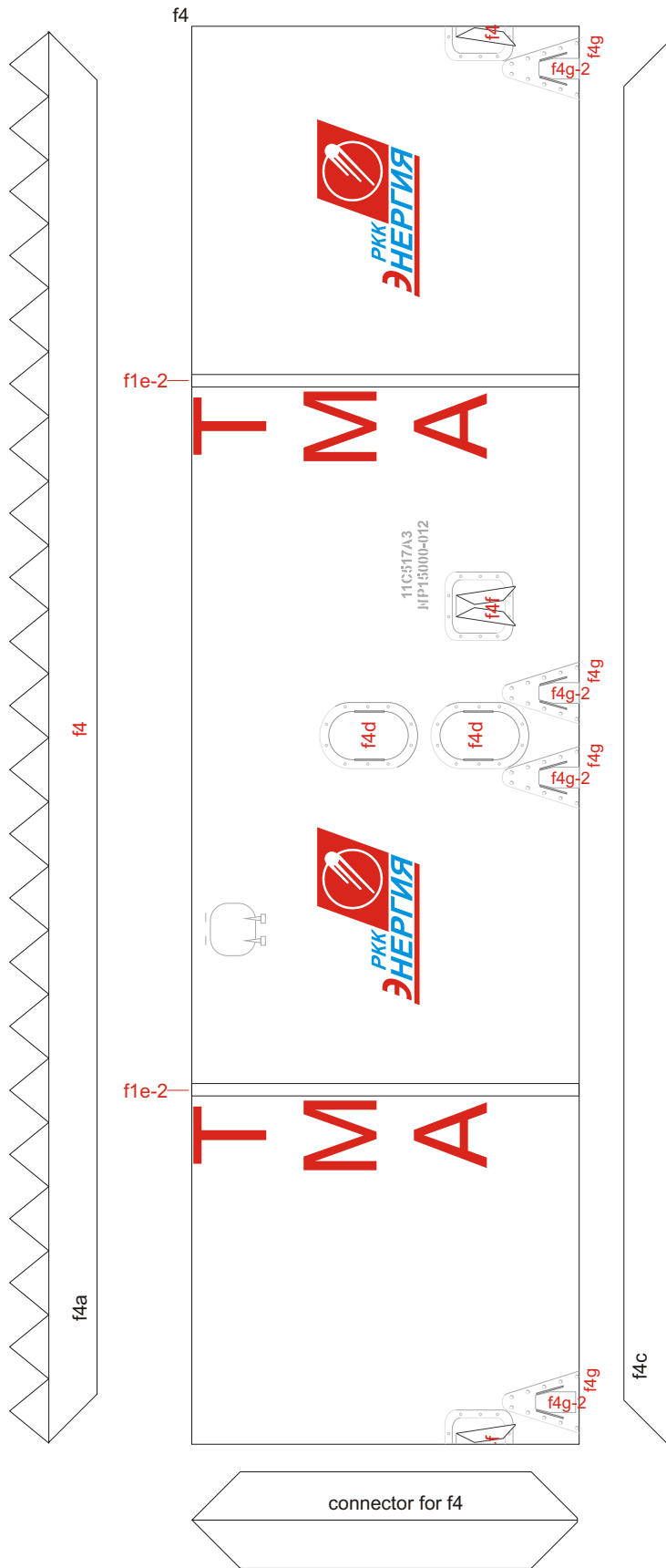

10 cm

0

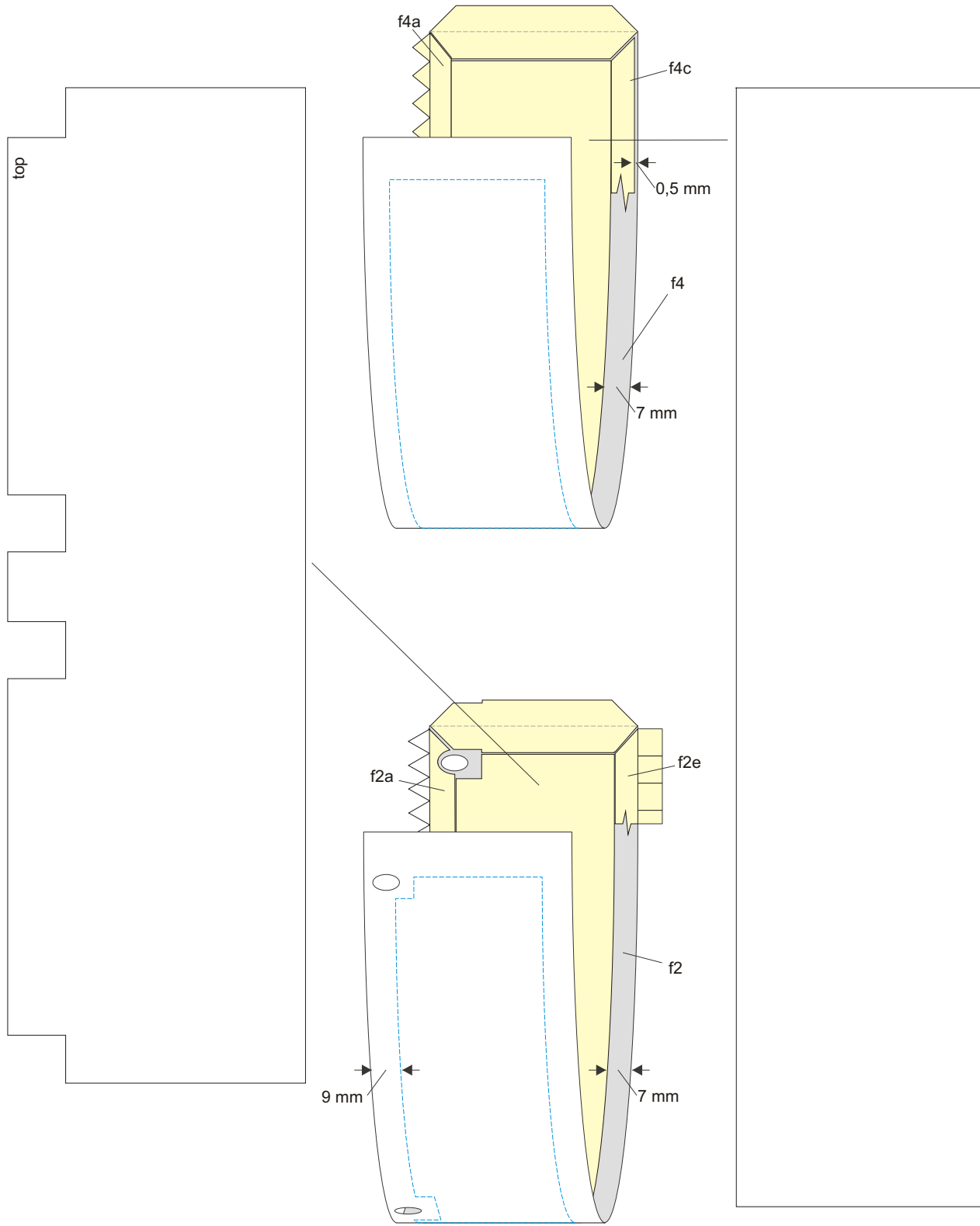

Optional parts for durability of cylinders f2 and f4

