

50 years of Gagarin's space flight

www.cardmodels-r.narod.ru

SOYUZ FG

1:48 scale launcher

5.04.2011

Soyuz TMA-21 "Gagarin"

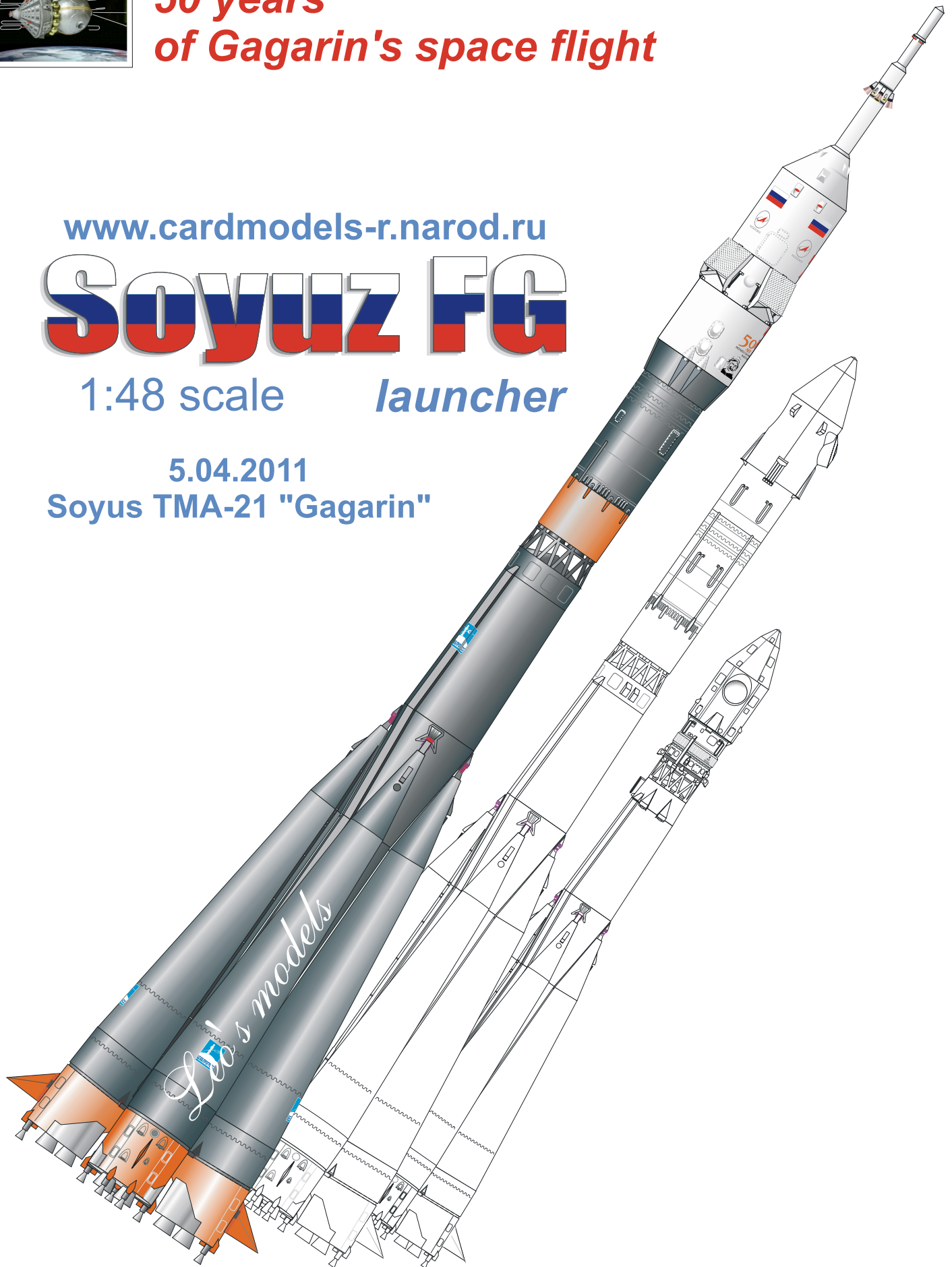

Fairing

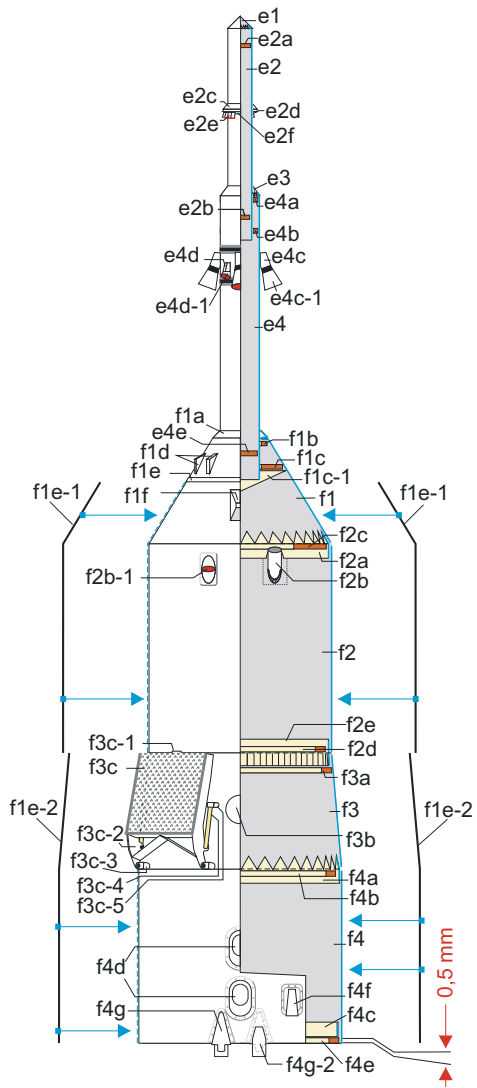

Stage 3

front view

back side view

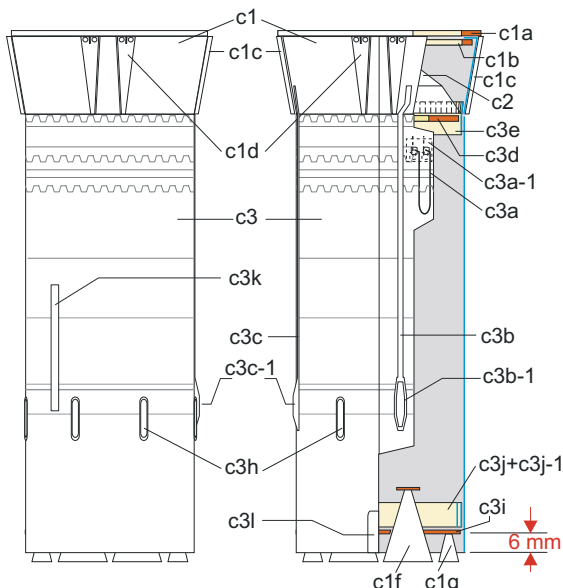

Paper used:
 0,15 mm - 130 gr
 0,26 mm - 200 gr ("cardstock")
 Glue: PVA

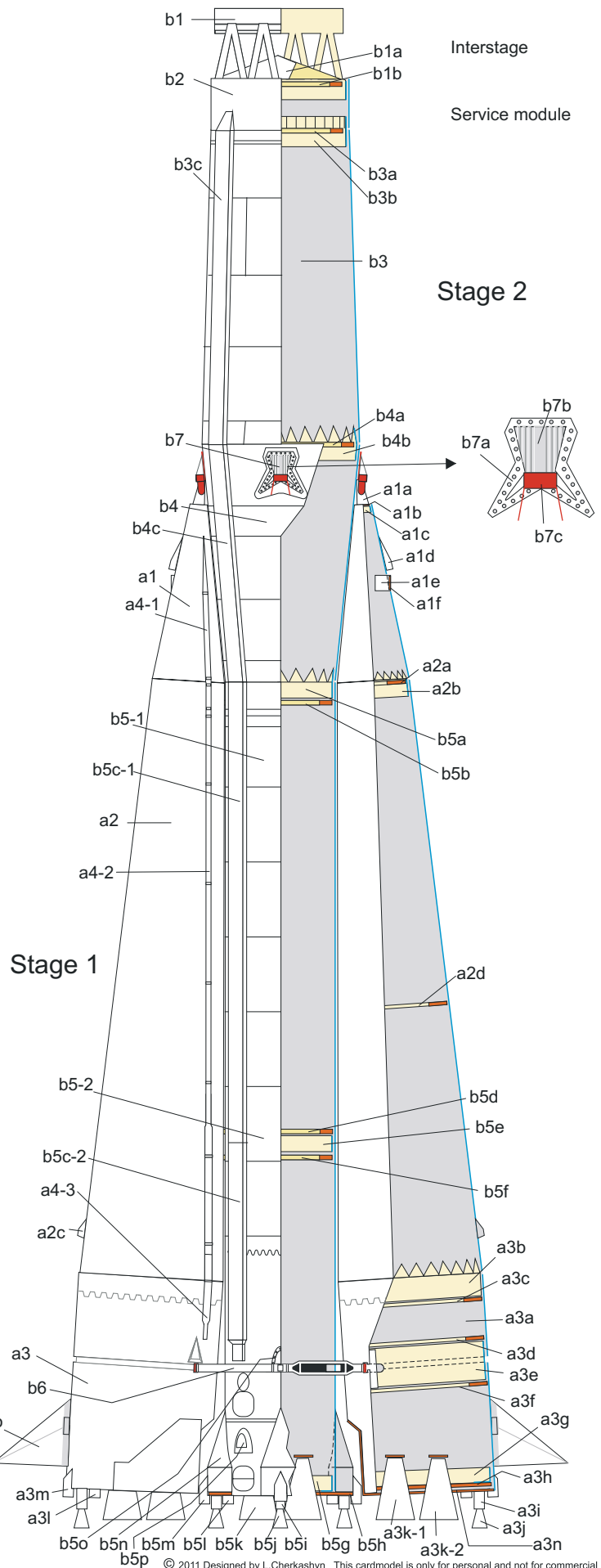

Stage 1

holes for assembling of Stage 1. Make ones only during assembling!

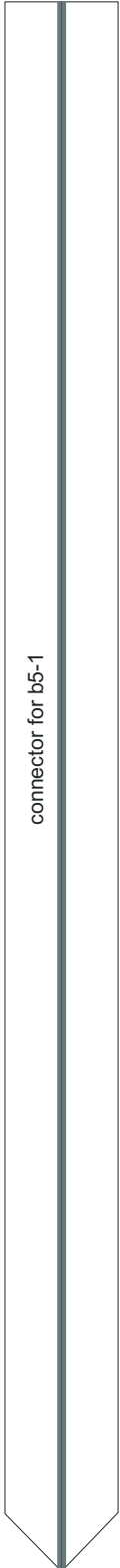

connector for b5-1

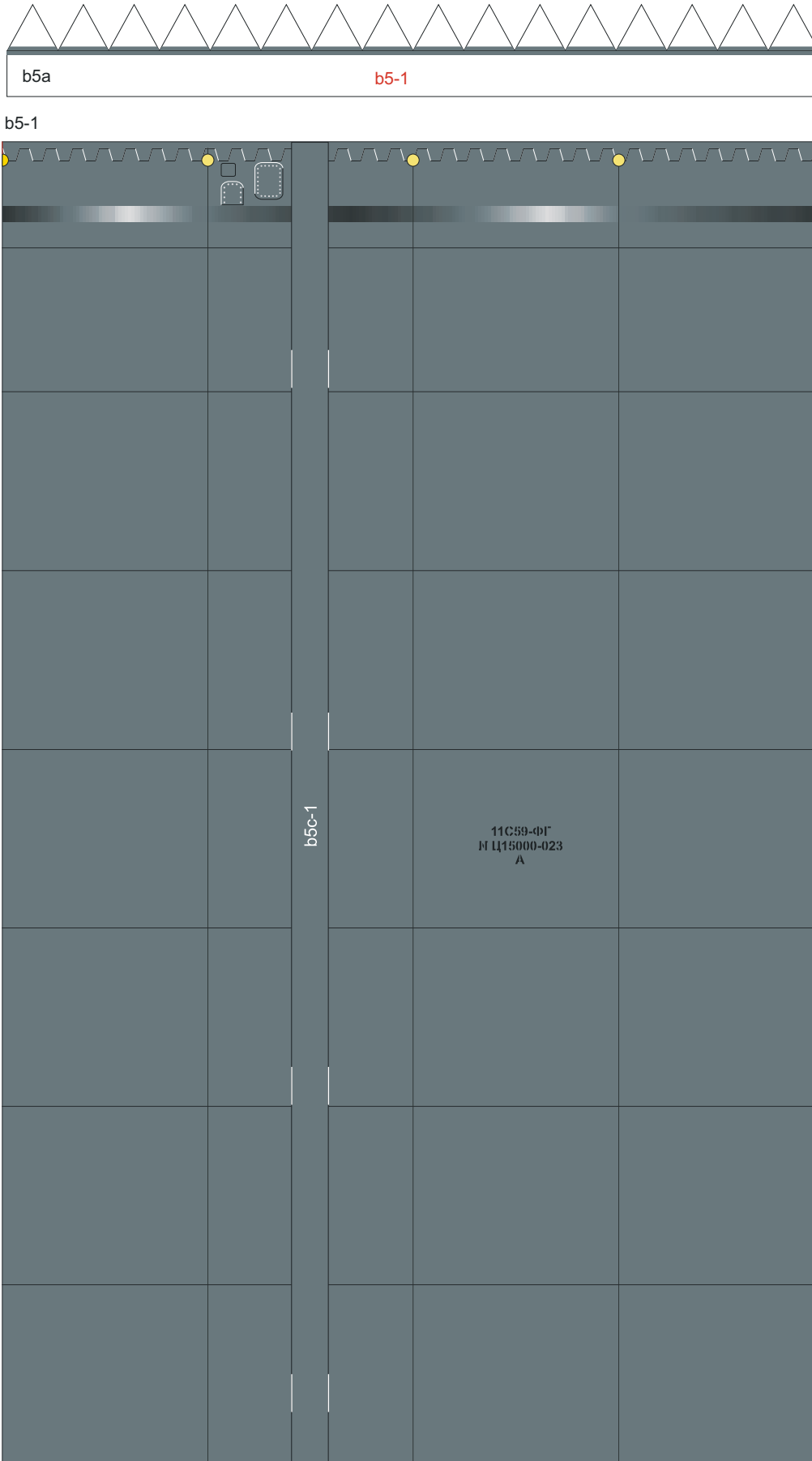

white slots for b5c-1

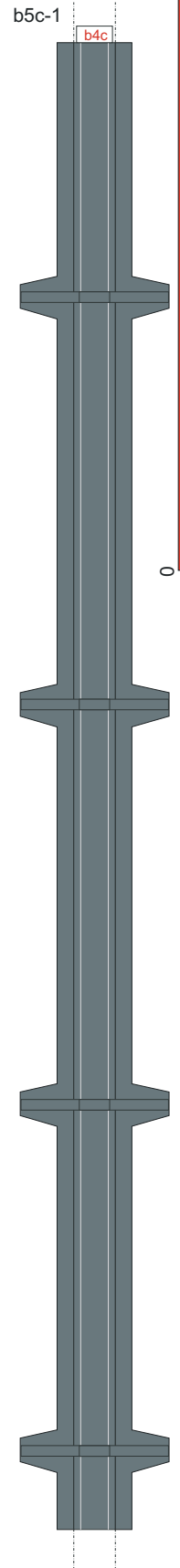

10 cm

0

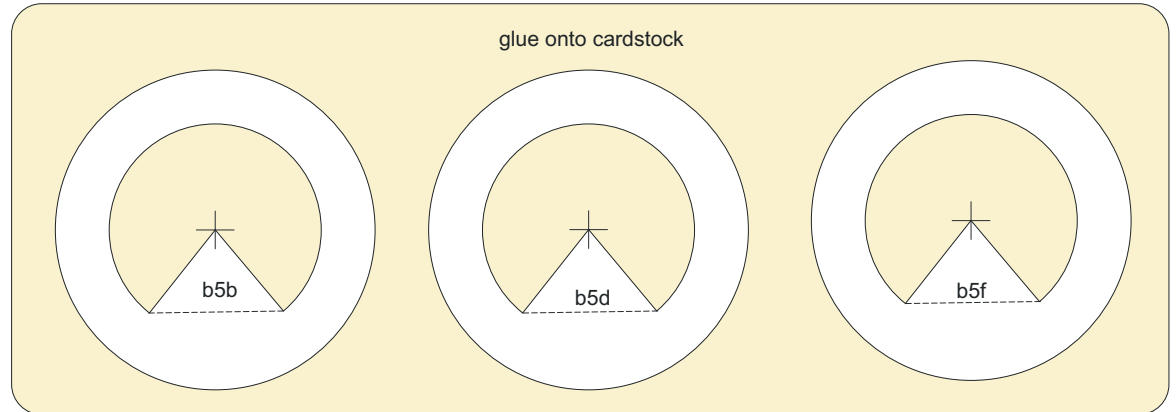
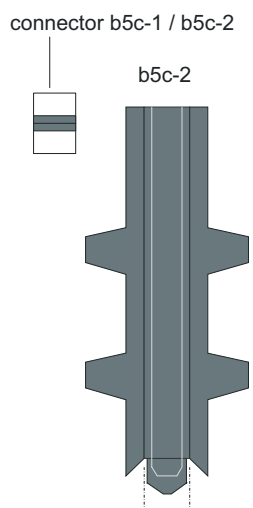
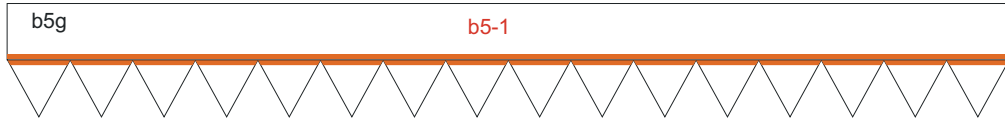
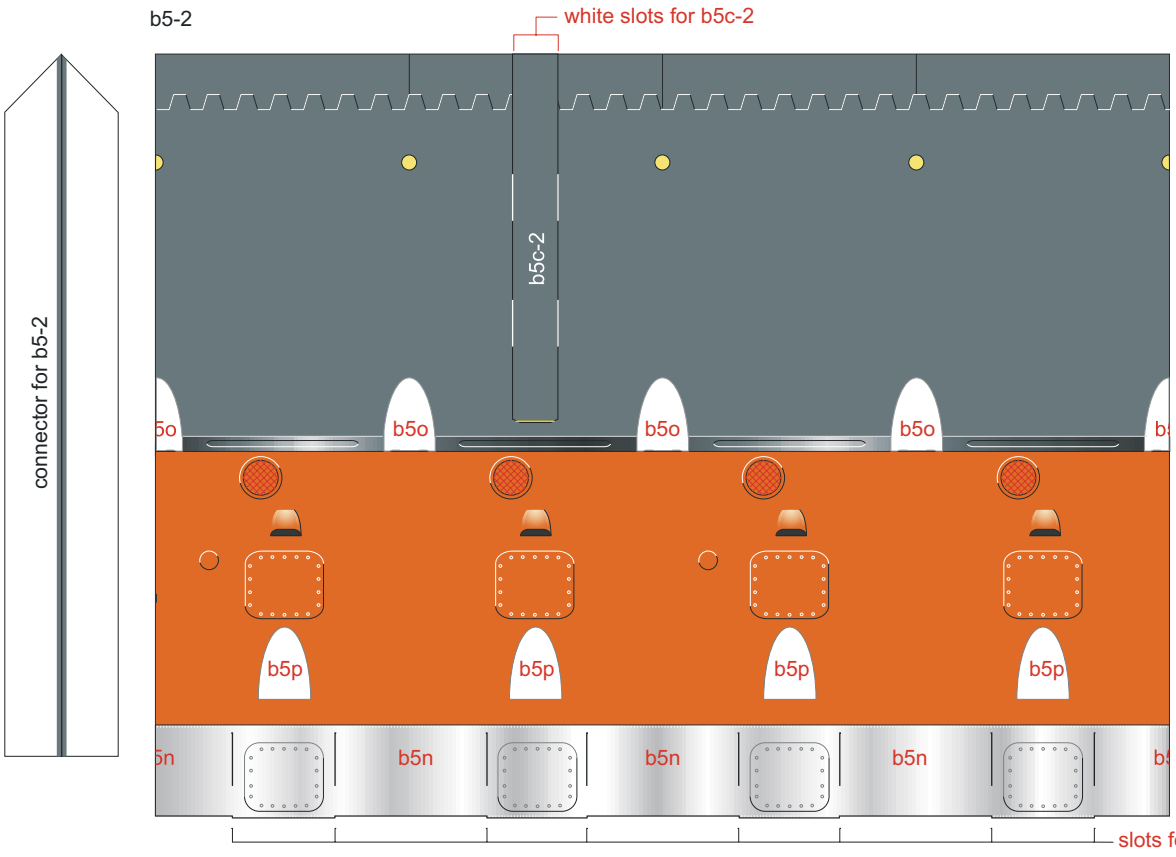
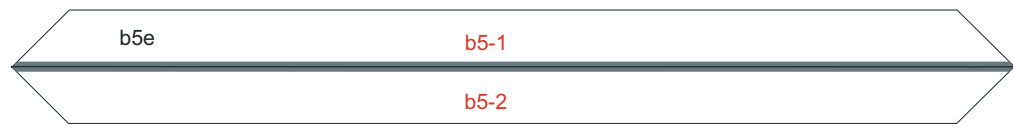

Internal parts of nozzles b5j and b5k



ends of b6 for inserting to Stage 1

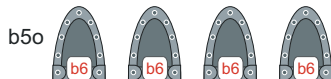
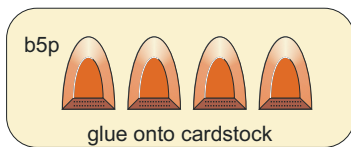
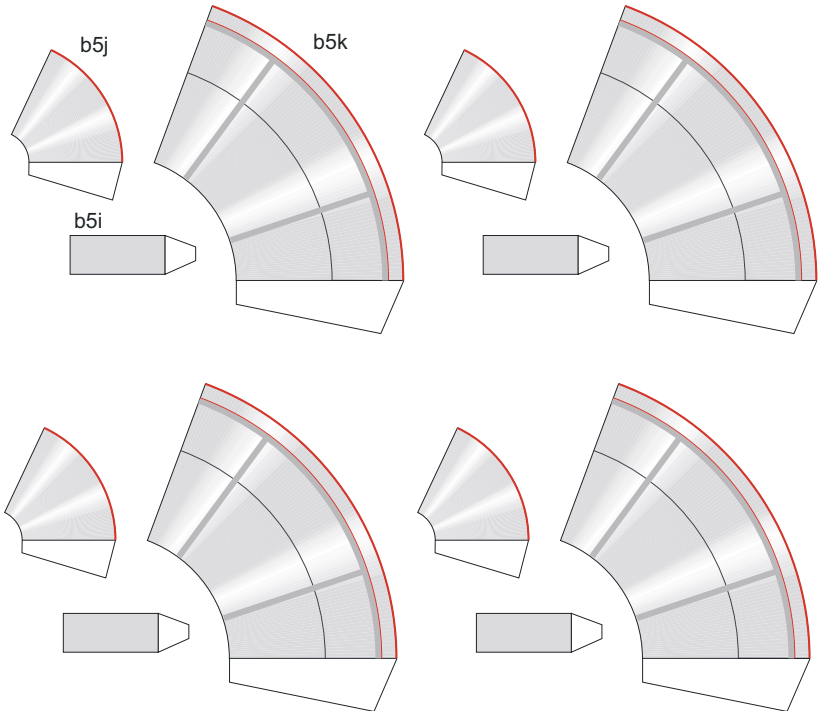
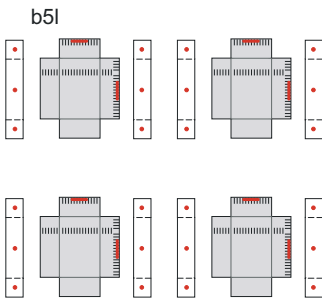
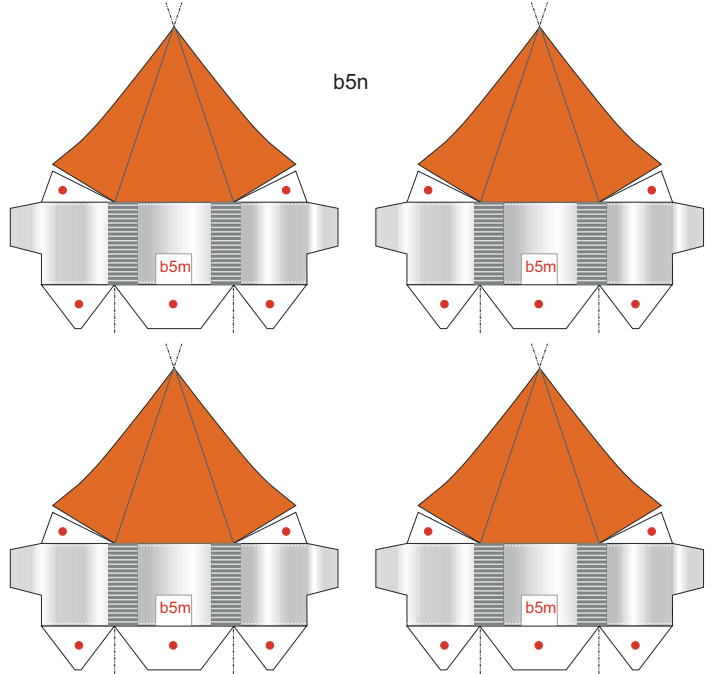
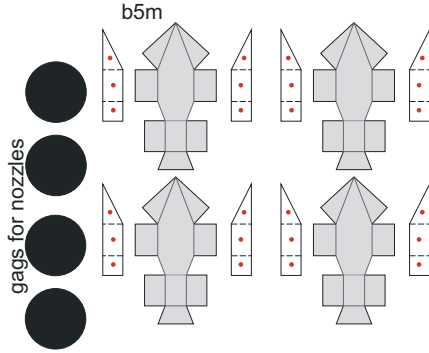
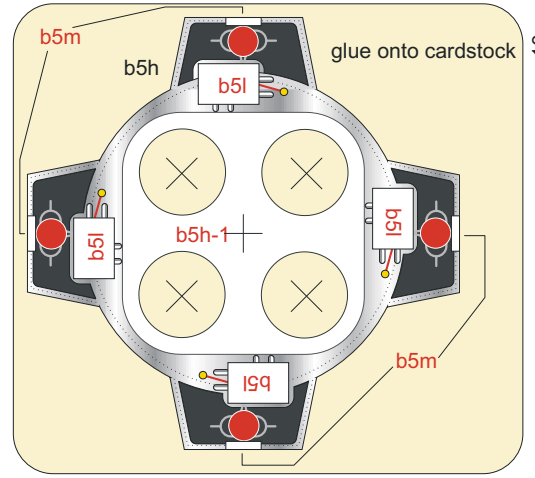
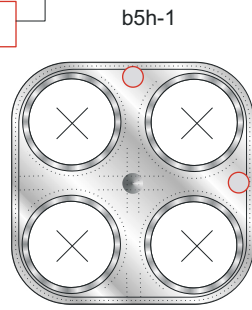
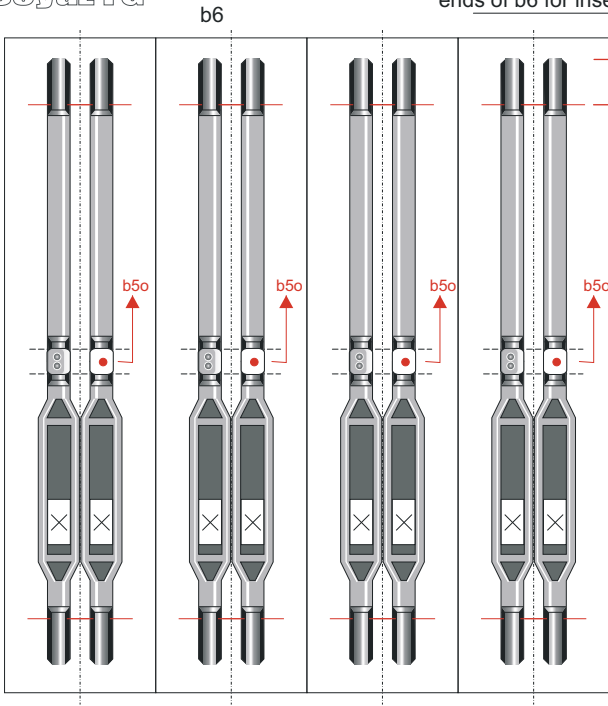

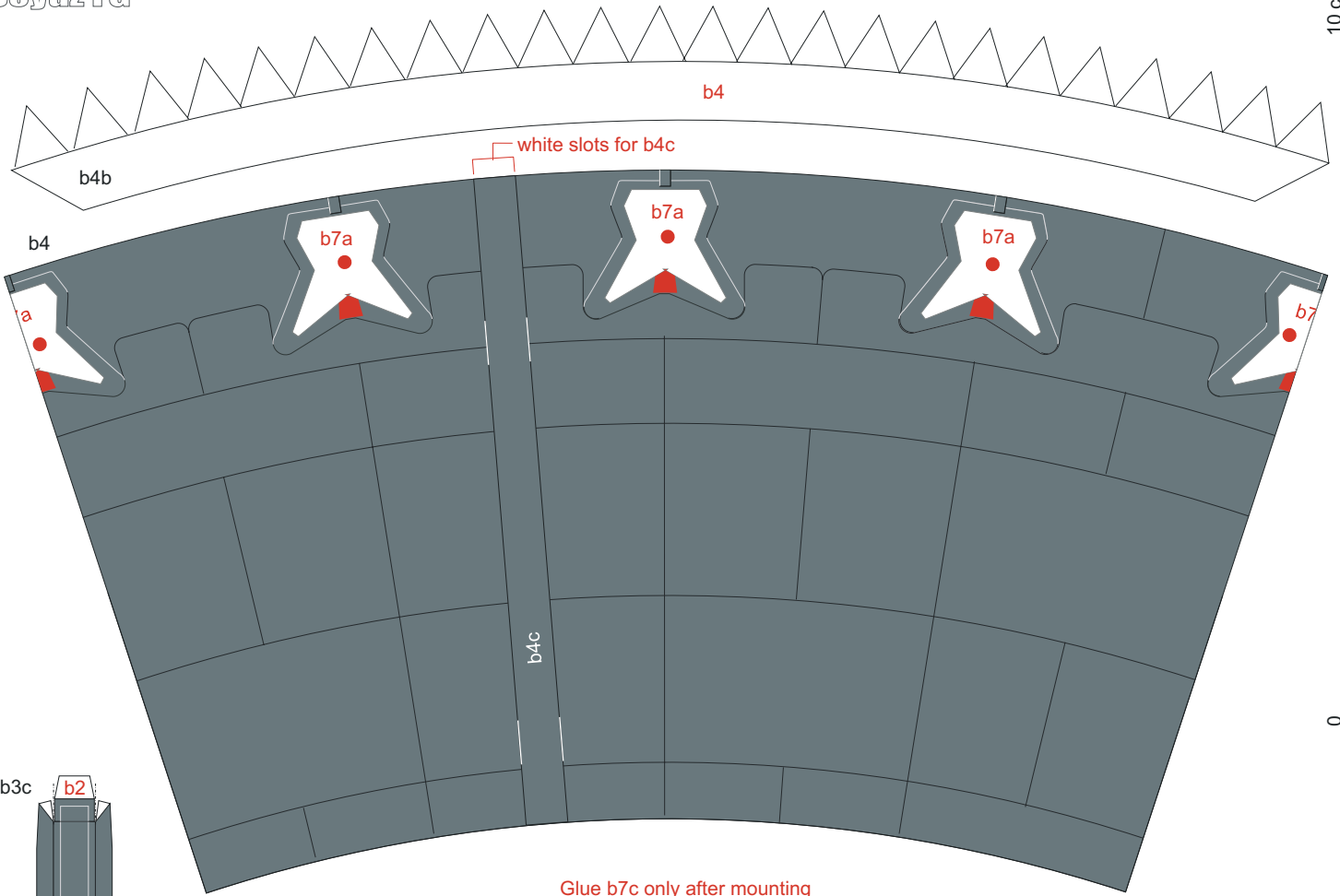

Glue b7c only after mounting blocks of stage 1 onto stage 2 !

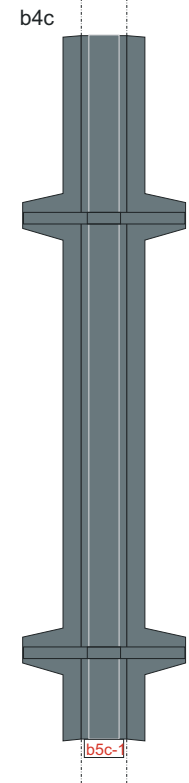
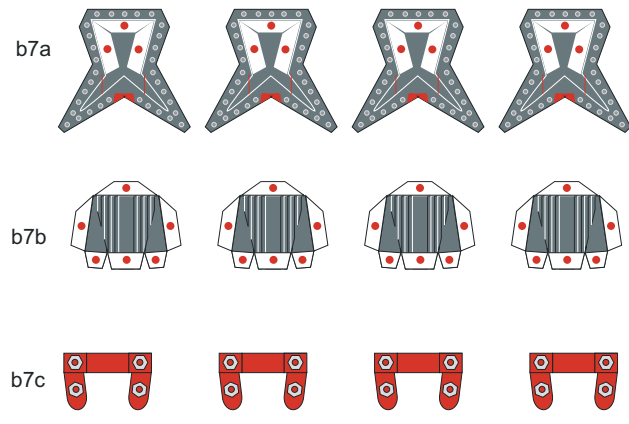
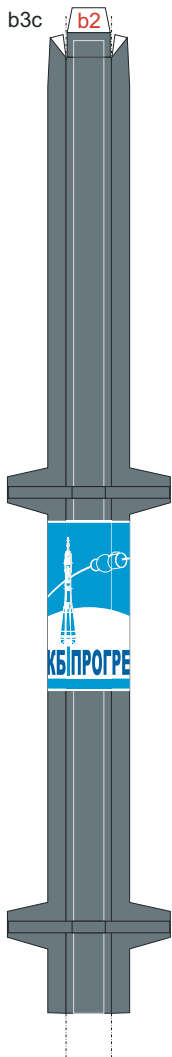
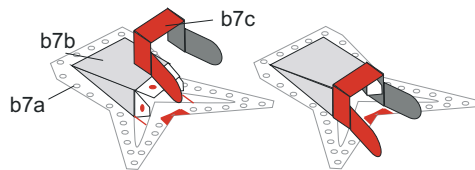

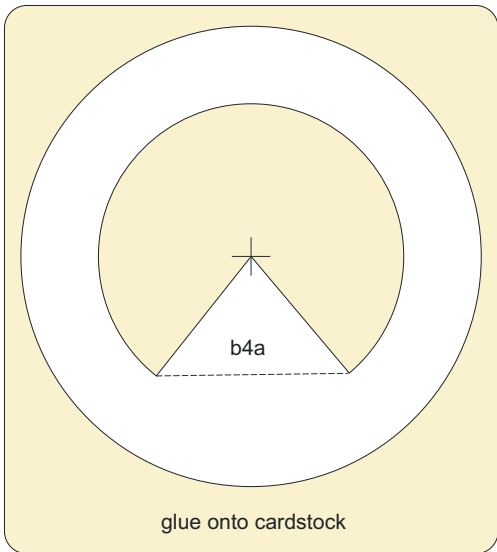
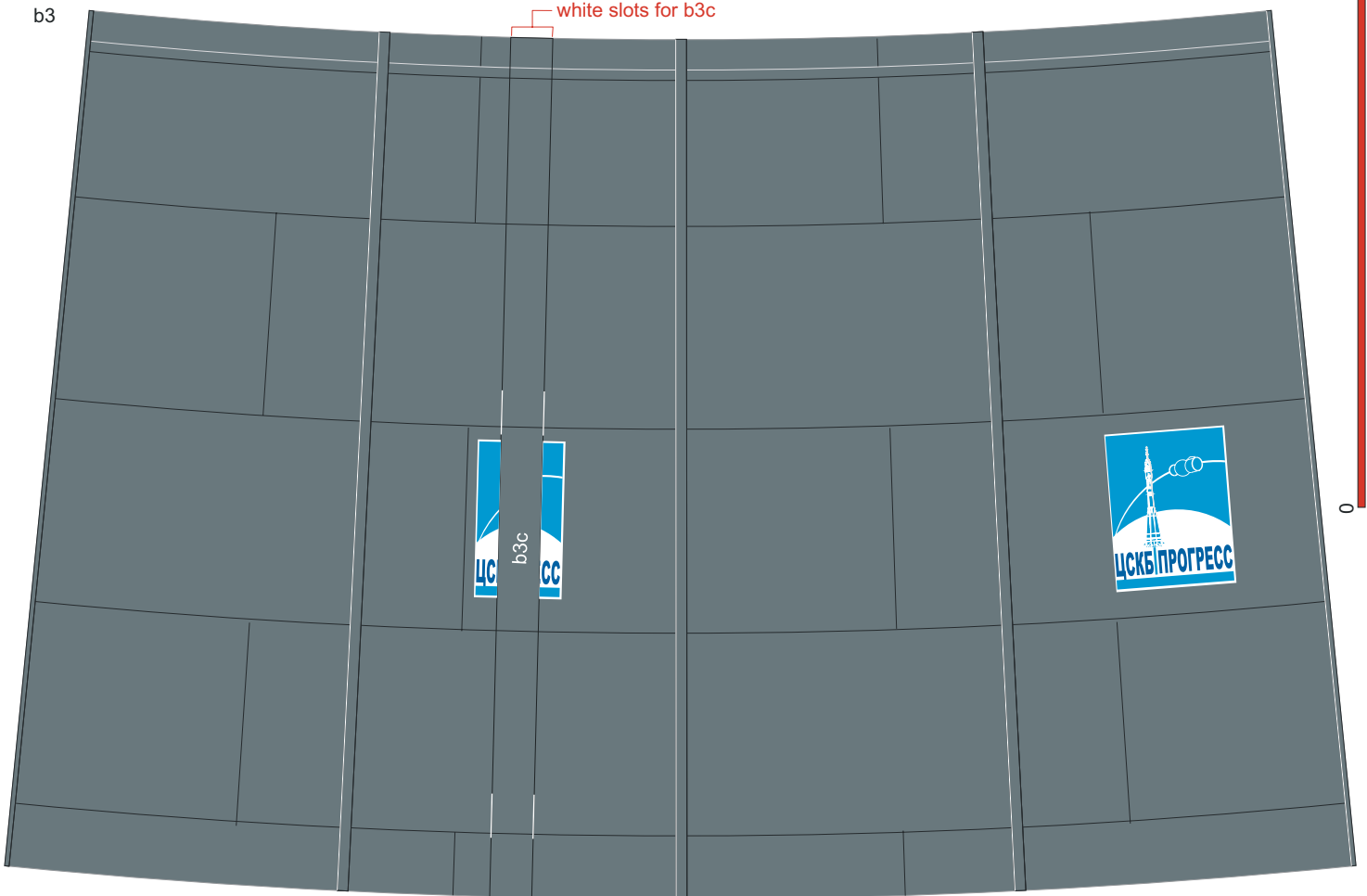
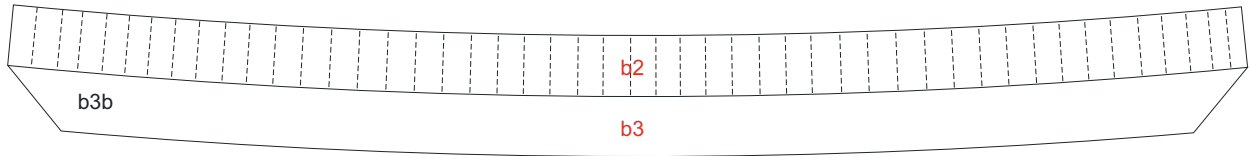

Internal parts of nozzles c1f and c1g

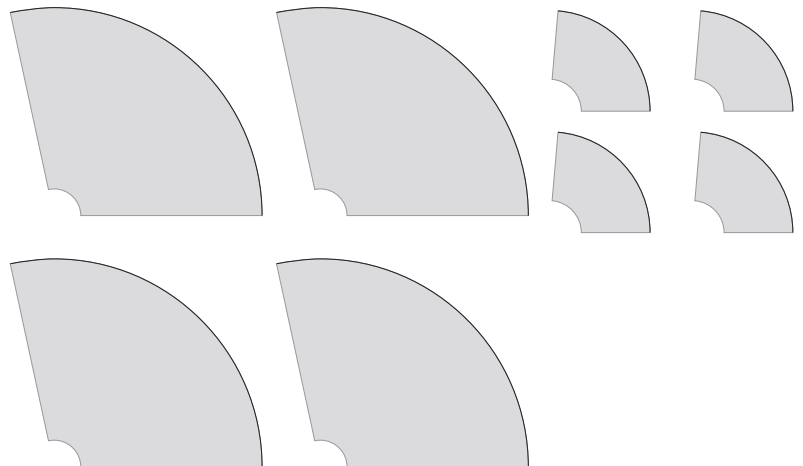

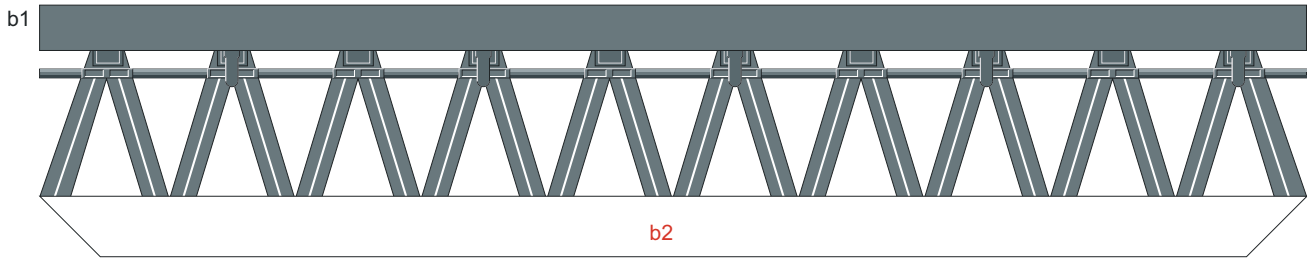

glue onto back side of part b1 before cut one

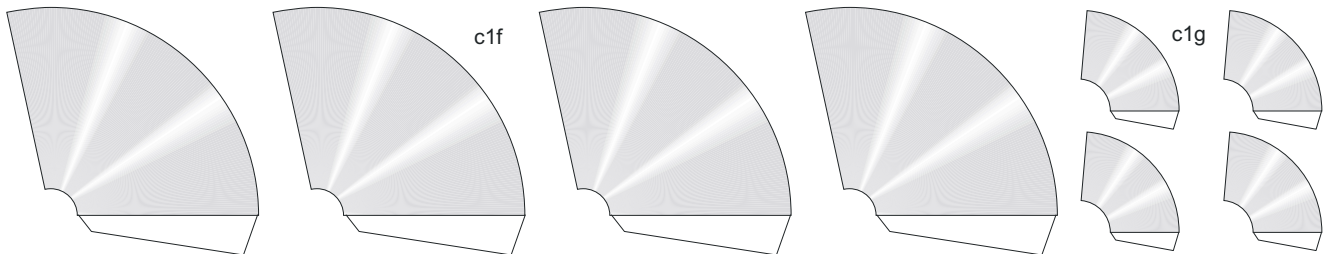
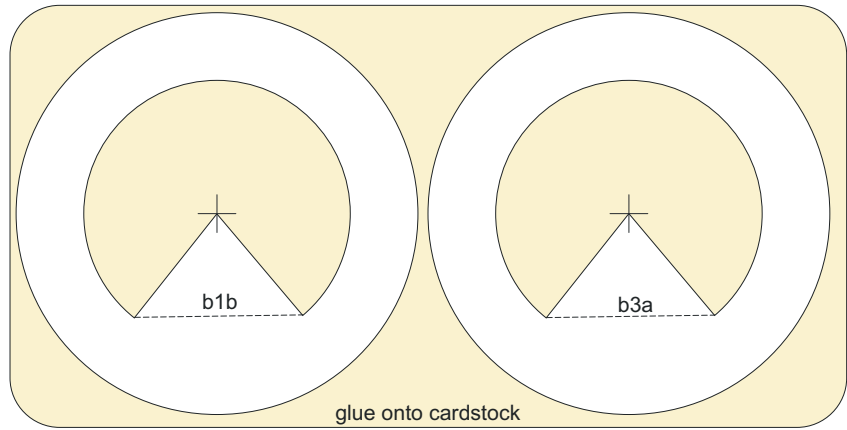
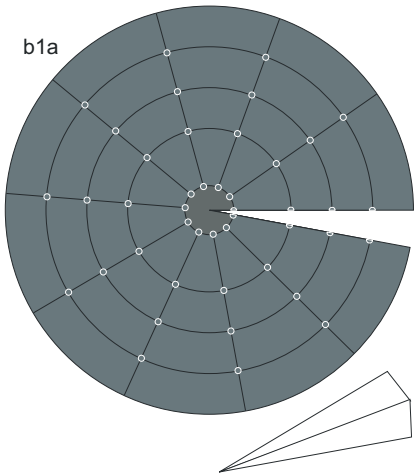
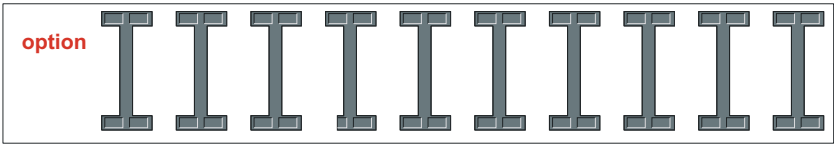
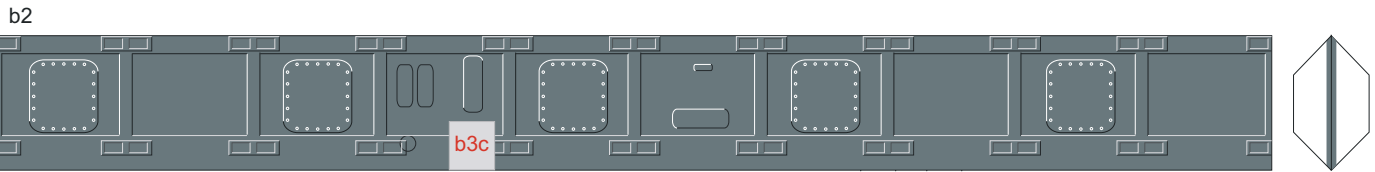

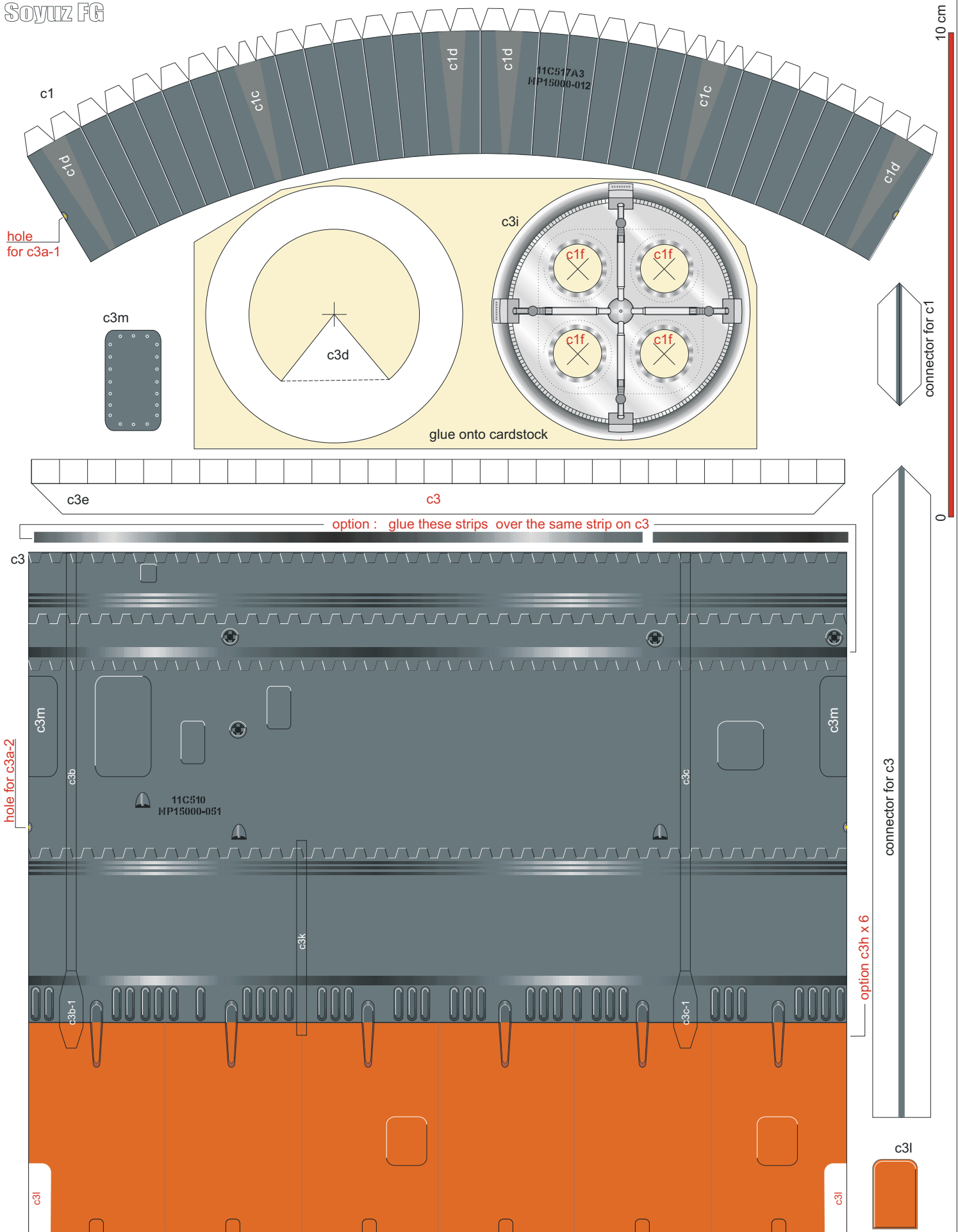

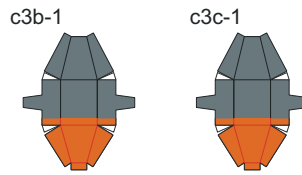
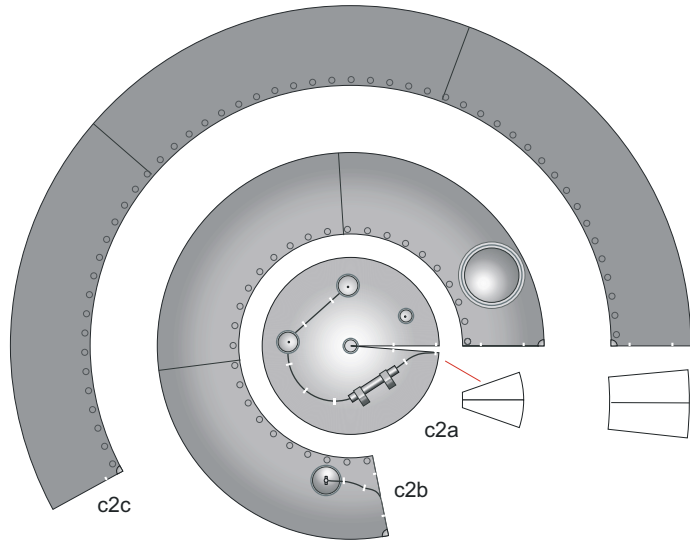
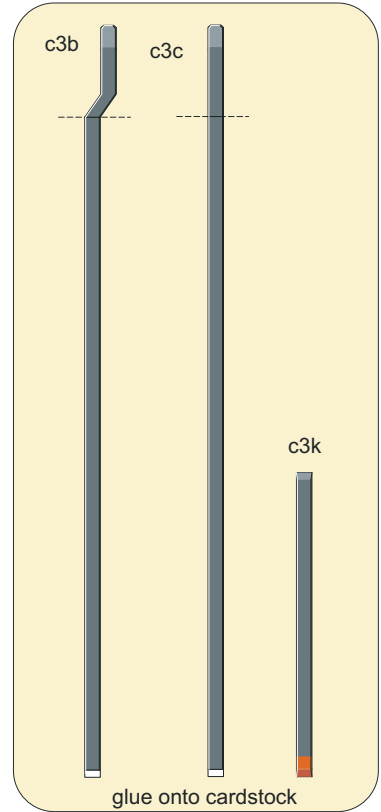
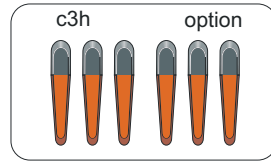
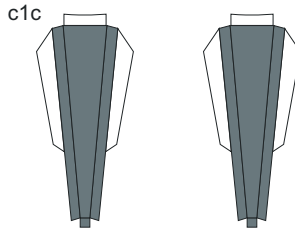
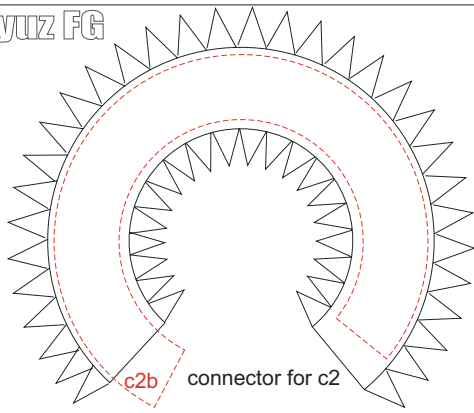

"silver" wire d~0,5 mm

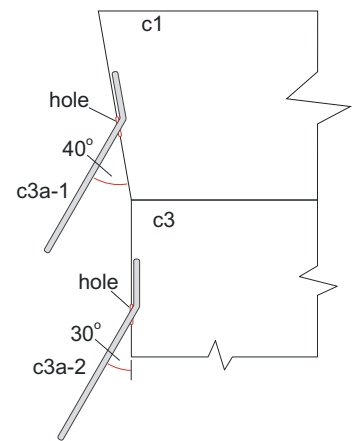
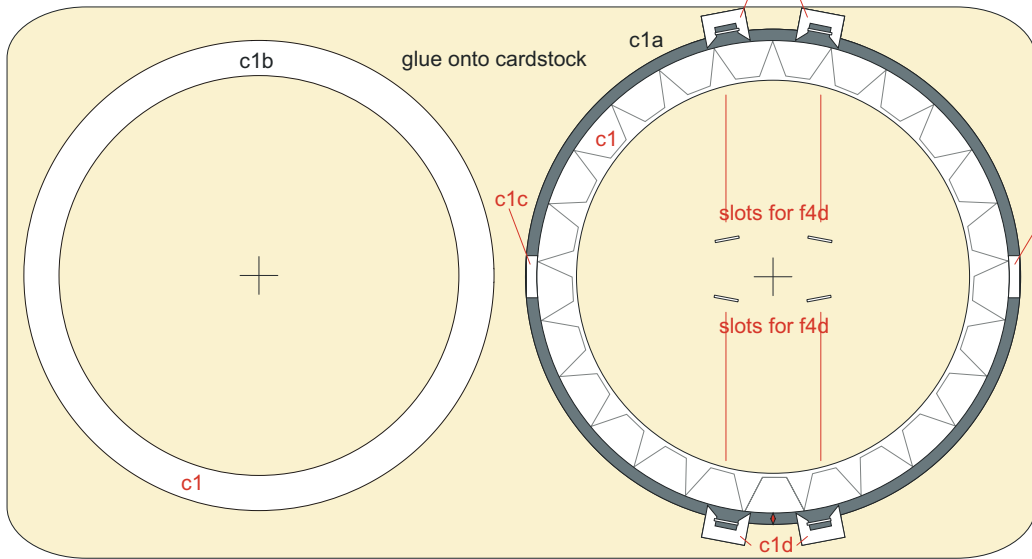
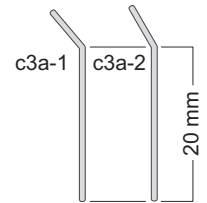

c3j	c3
supports fo c3i	
c3j-1	c3j

