

Voskhod launcher

1:48 scale

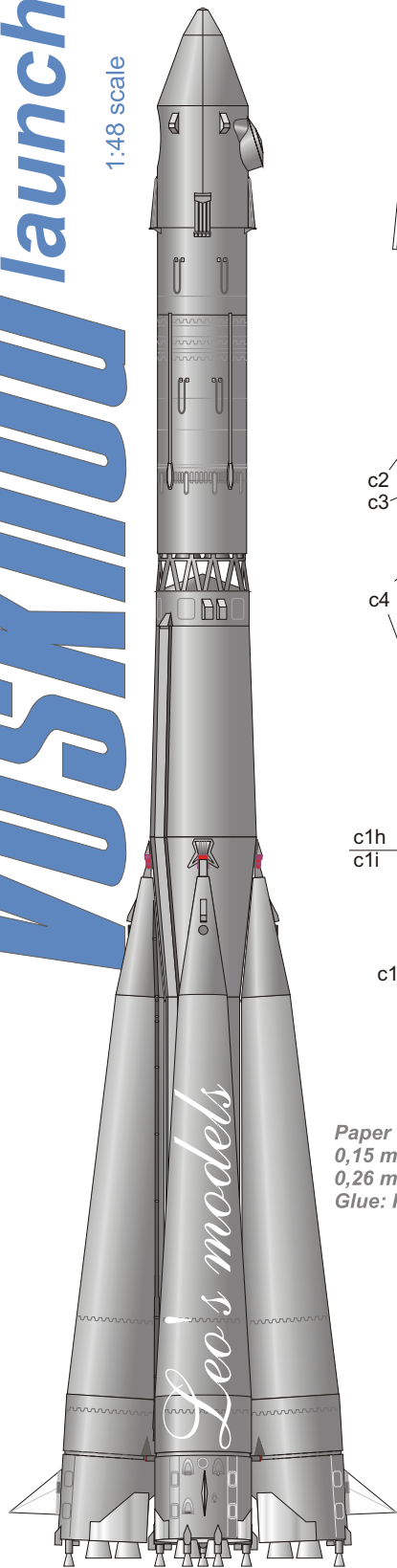

Fairings: 1 - for Voskhod spacecraft
2 - for Voskhod-2 spacecraft

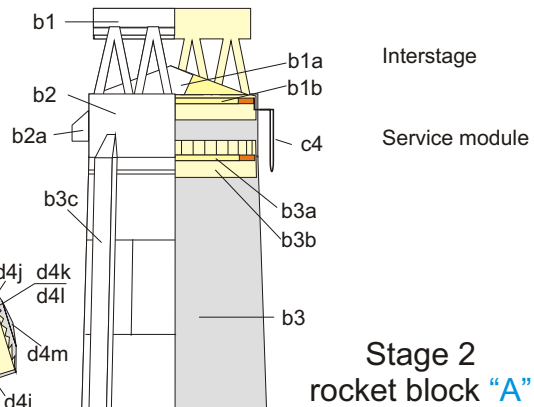
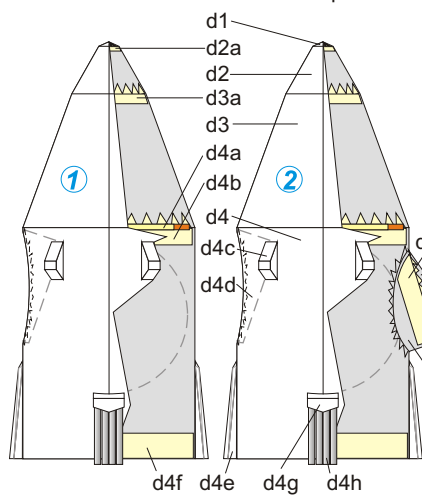

Stage 3 rocket block "V"

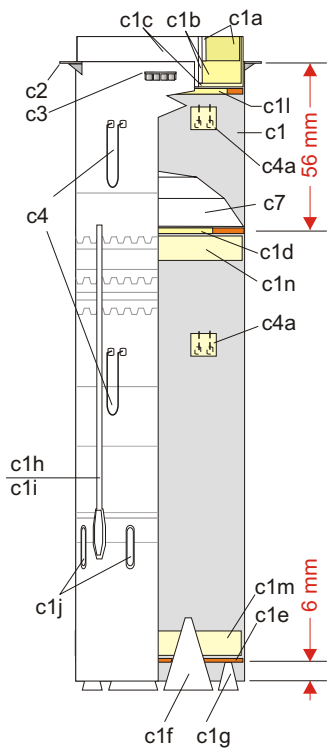

Paper used:
0,15 mm - 130 gr
0,26 mm - 200 gr ("cardstock")
Glue: PVA

Stage 1 rocket blocks "Б", "В", "Г", "Д"

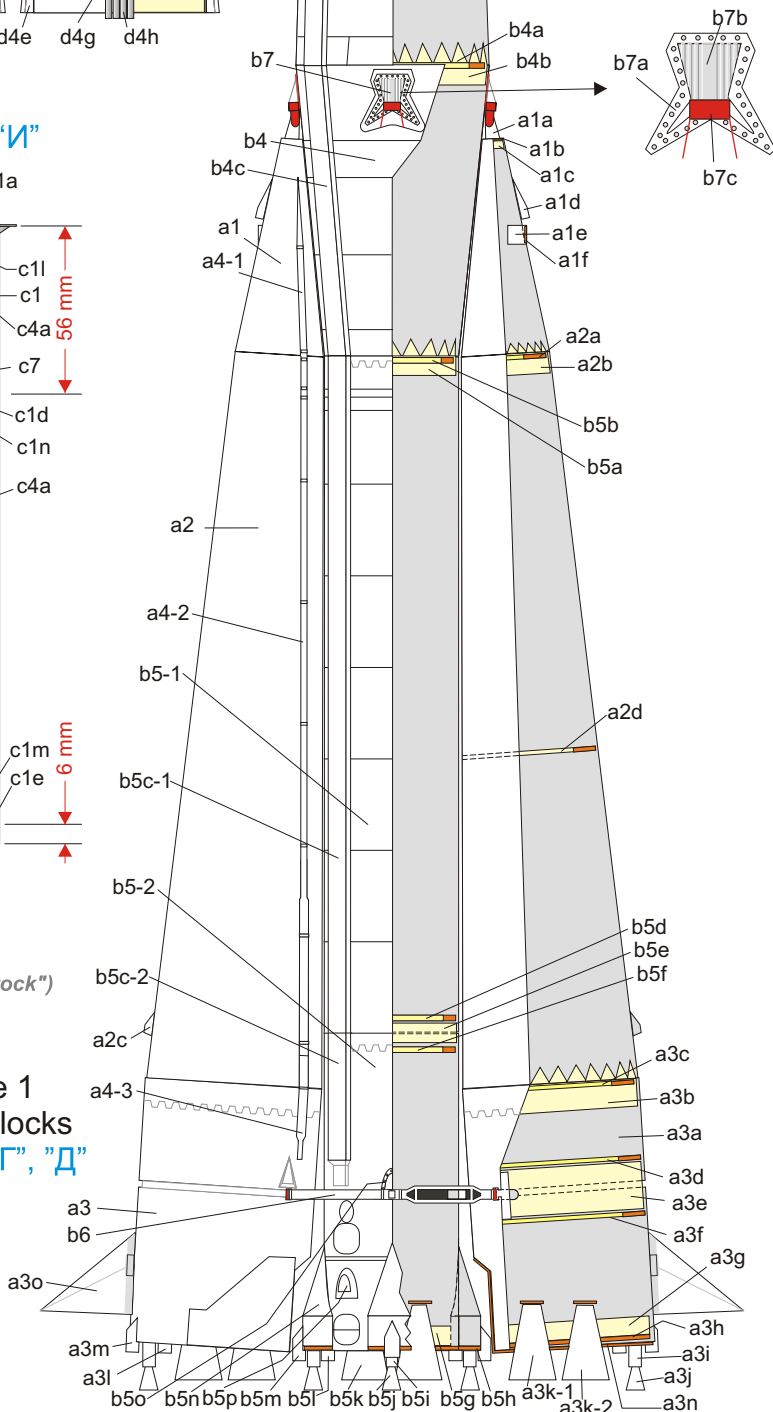

Many thanks to Joe Polchlopek for the test-building!

holes for assembling of Stage 1. Make ones only during assembling!

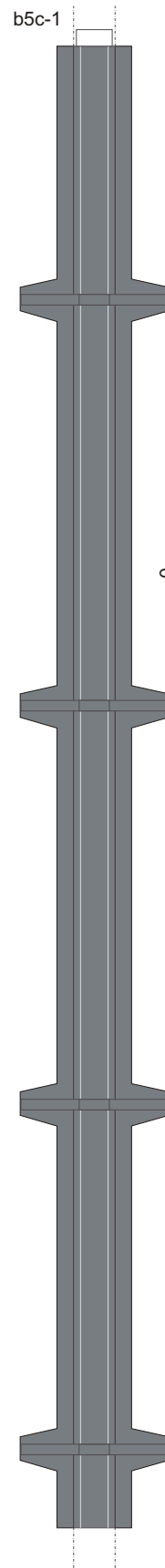
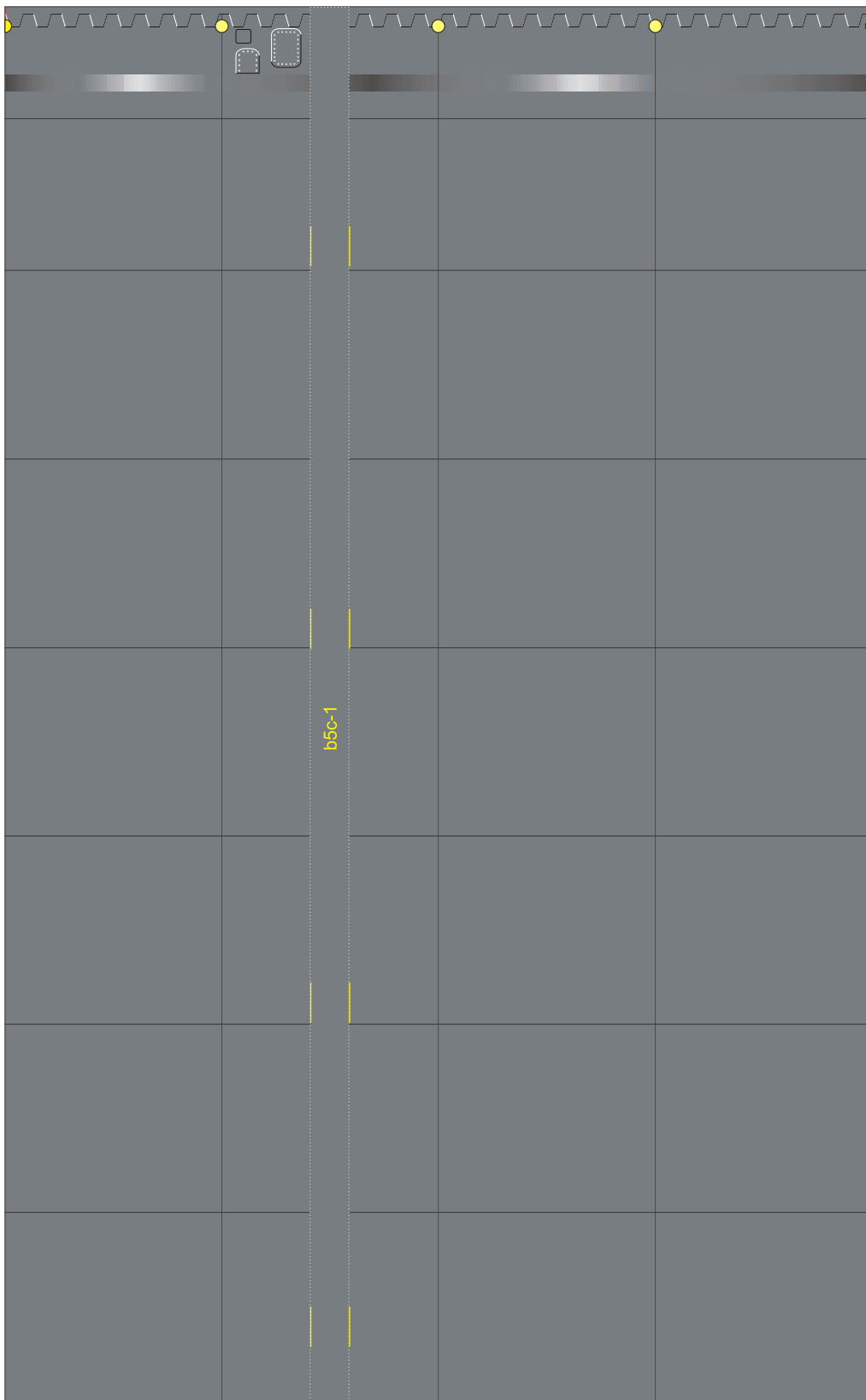
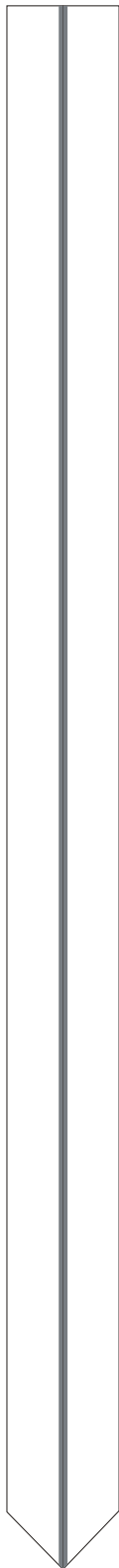
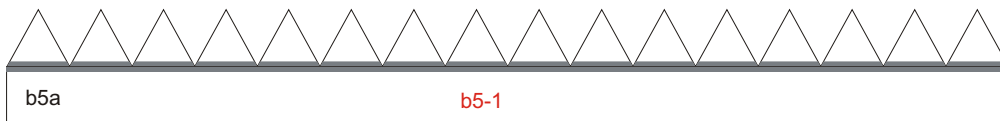

yellow slots for b5c-1



b5-2

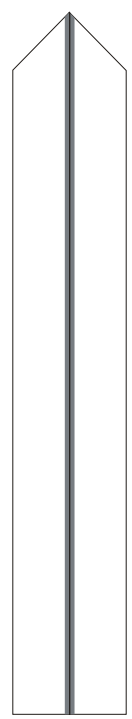

yellow slots for b5c-2

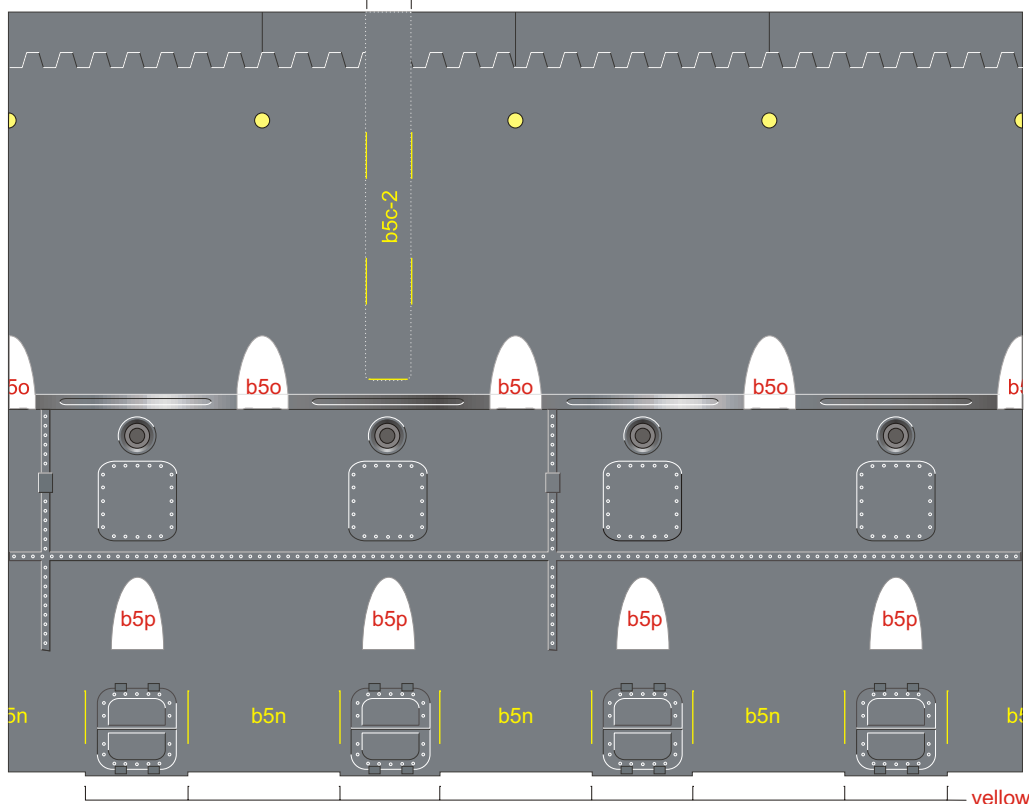

holes for assembling of Stage 1.
Make ones only during assembling!

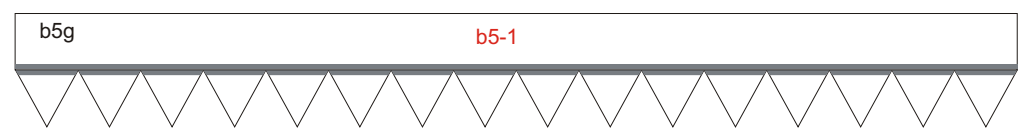

connector b5c-1 / b5c-2

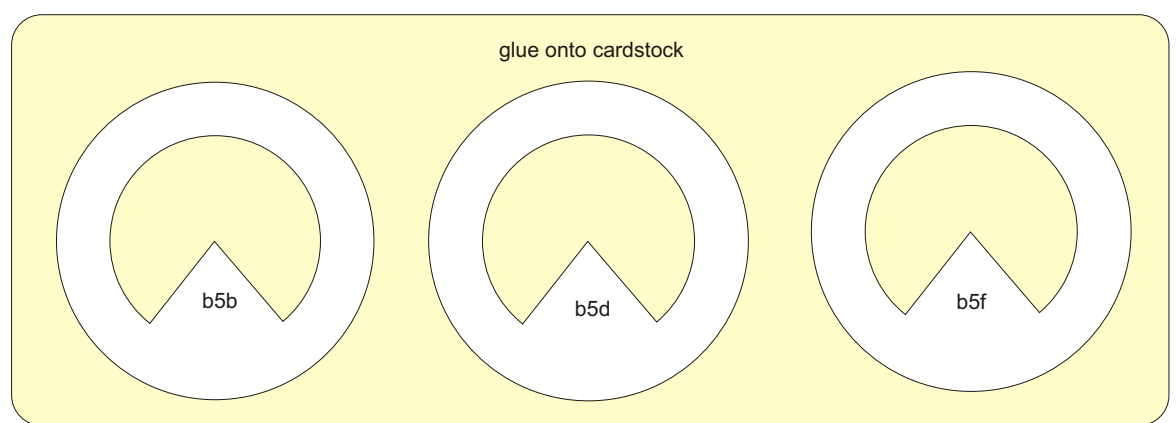
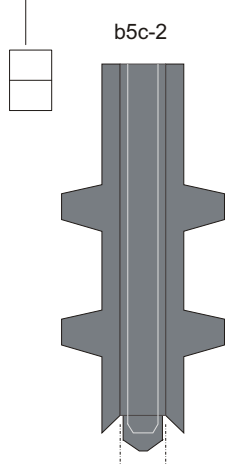

Internal parts of nozzles b5j and b5k

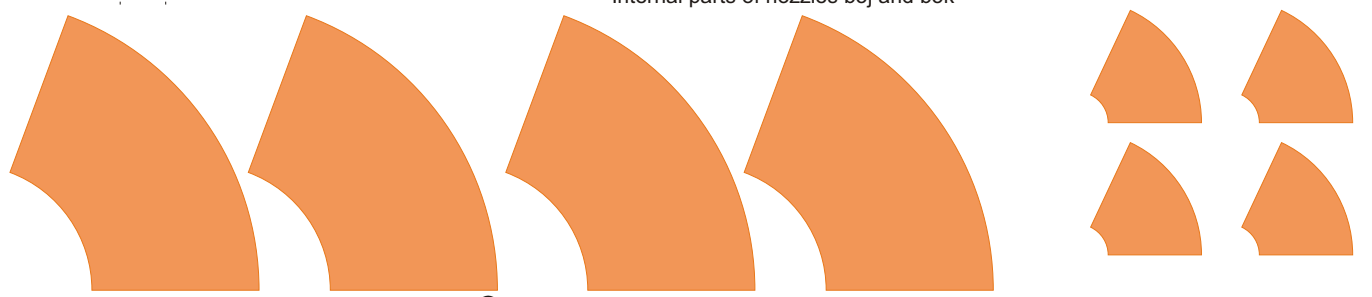

10 cm
0

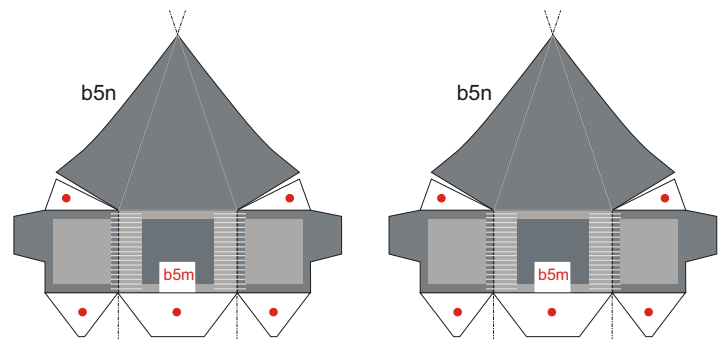
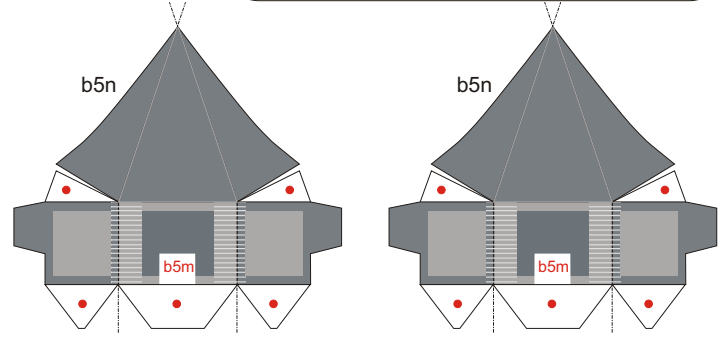
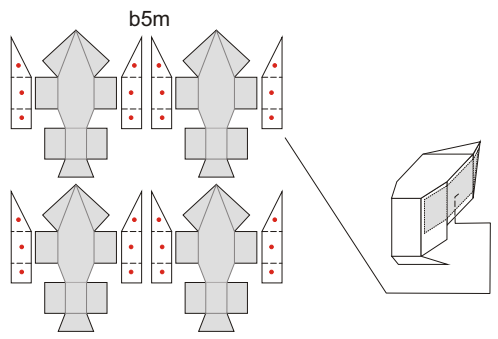
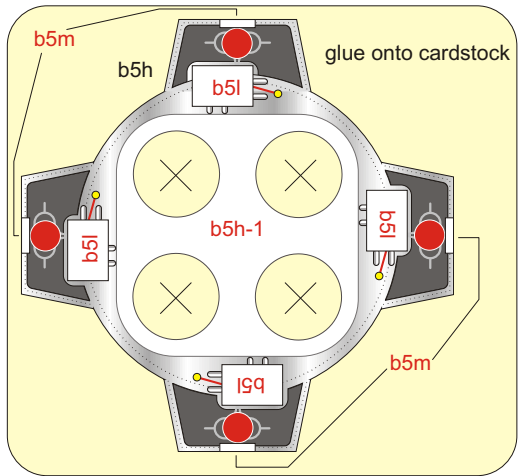
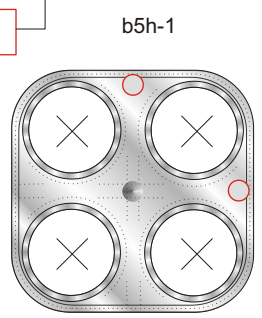
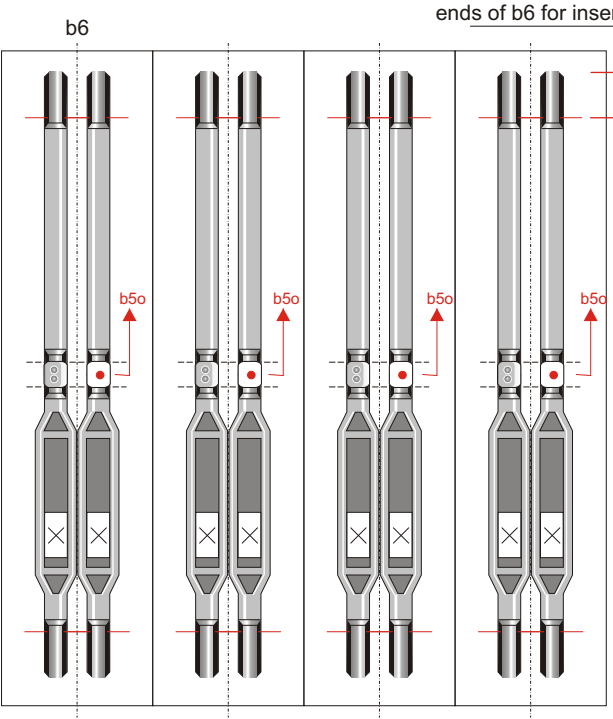

plugs for nozzles

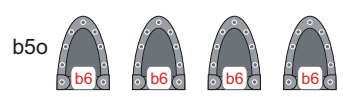
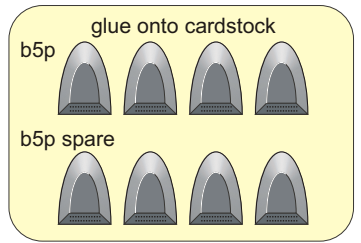
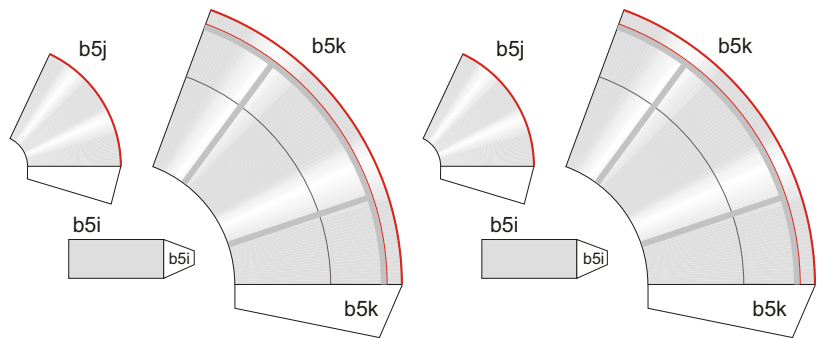
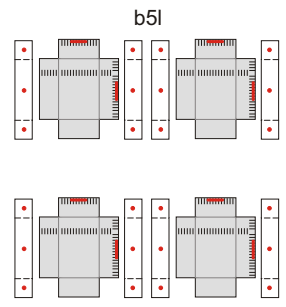

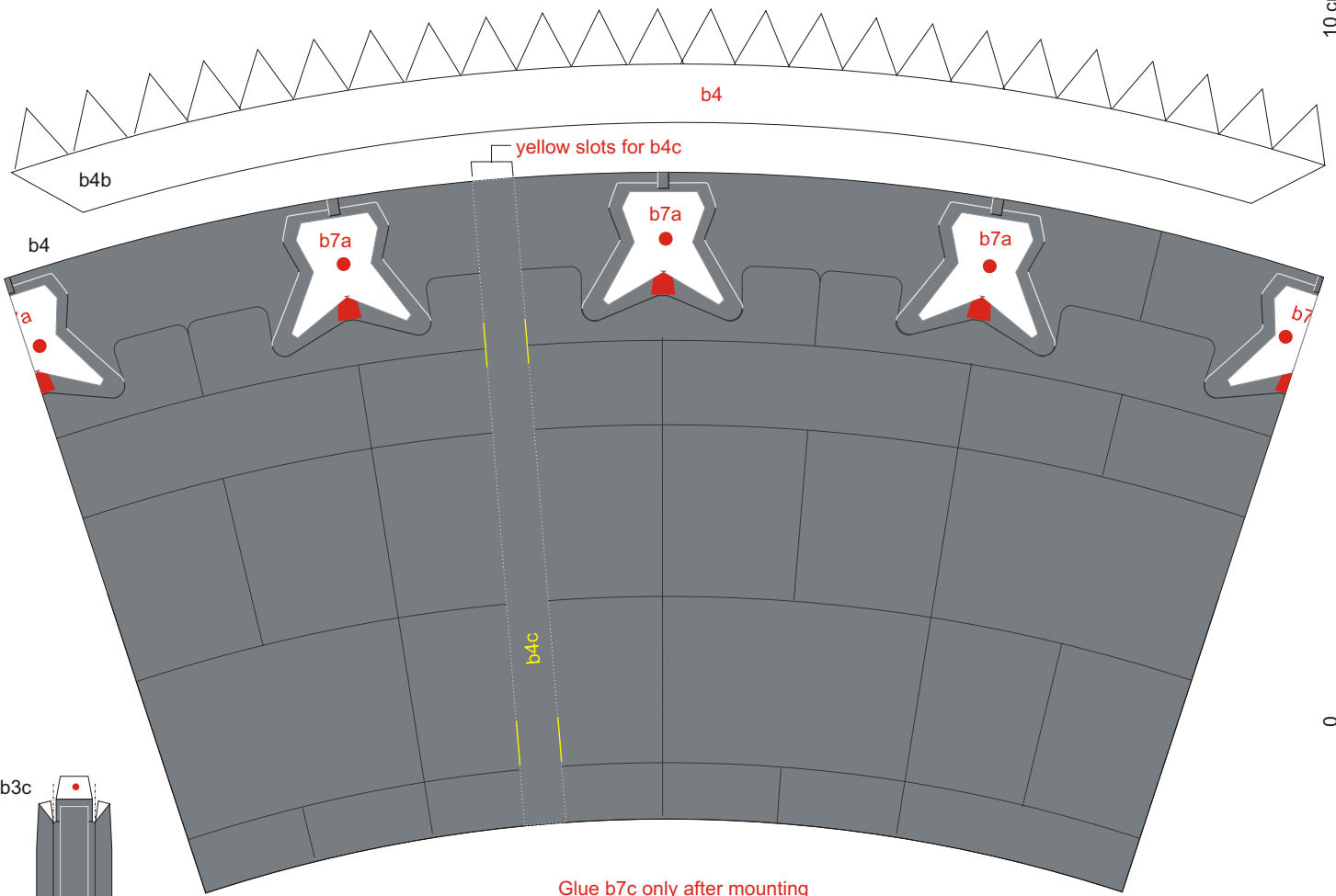

Glue b7c only after mounting blocks of stage 1 onto stage 2 !

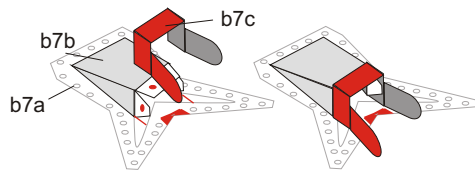

connector b3c-b4c

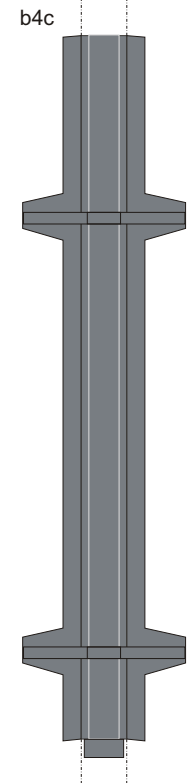
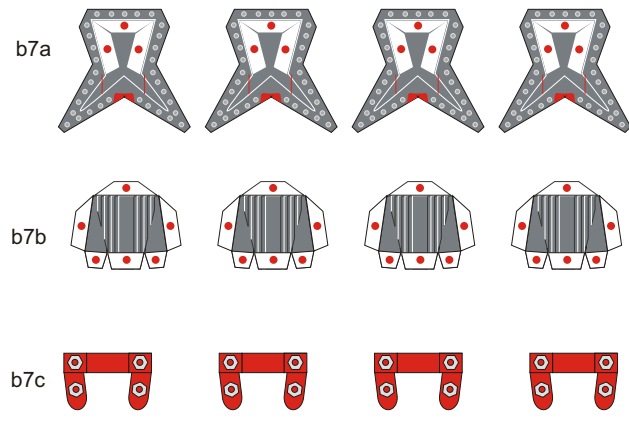
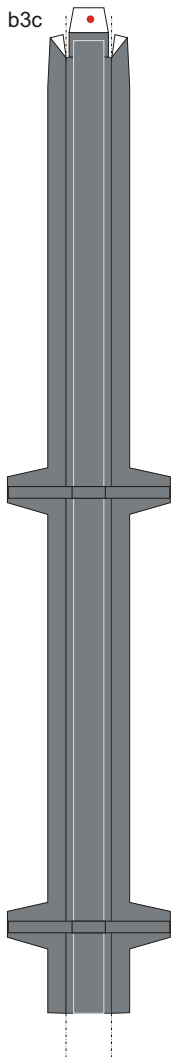

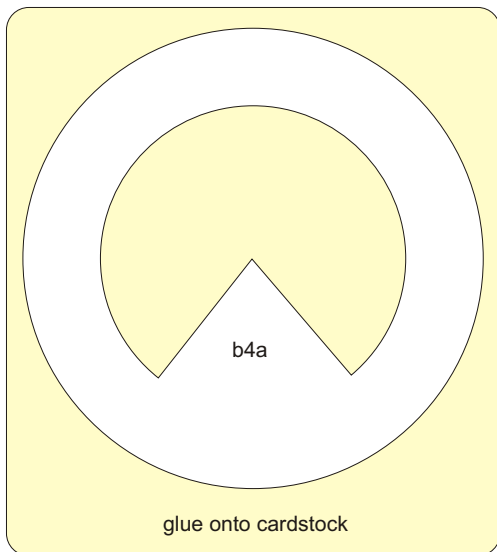
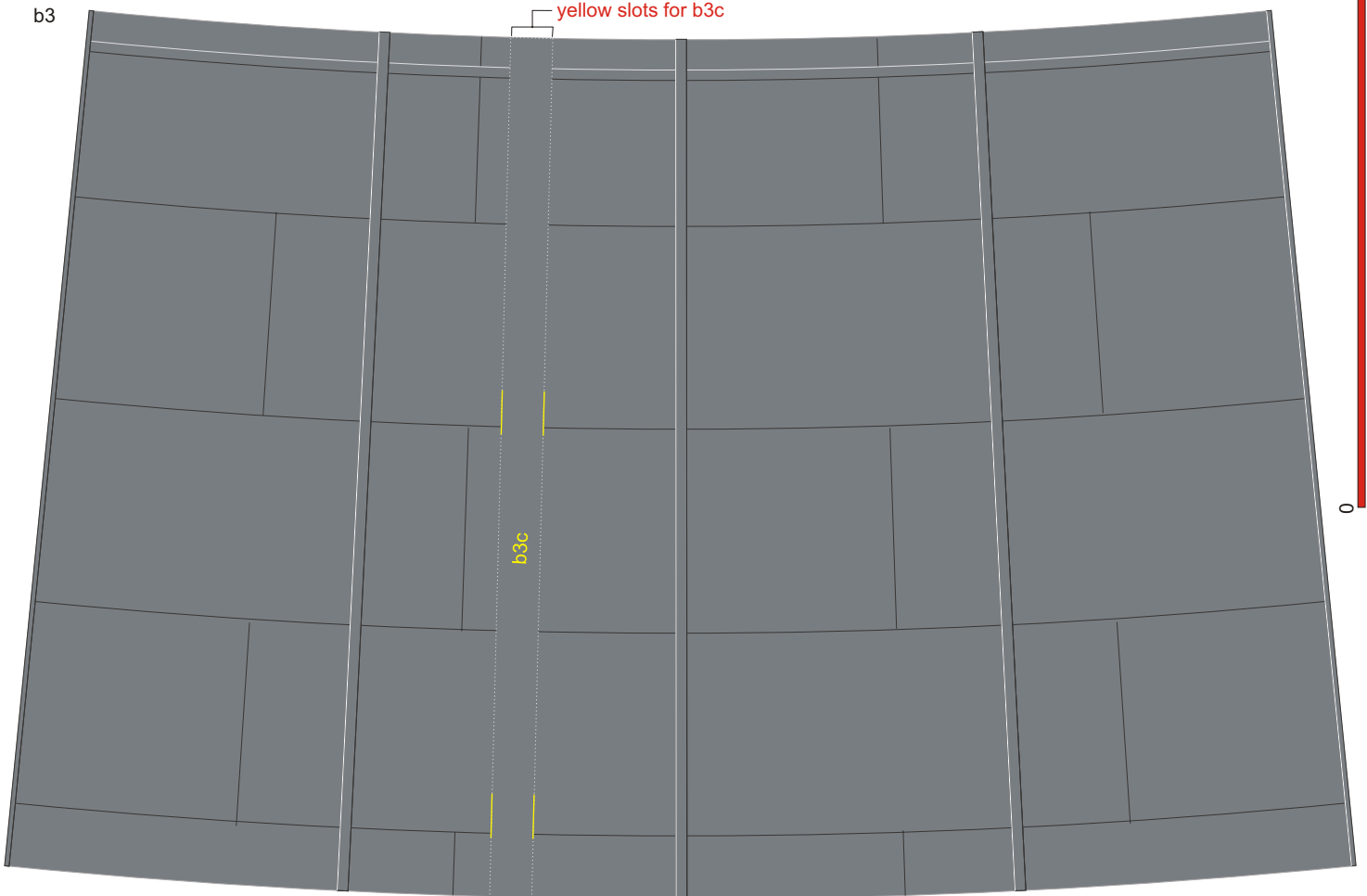
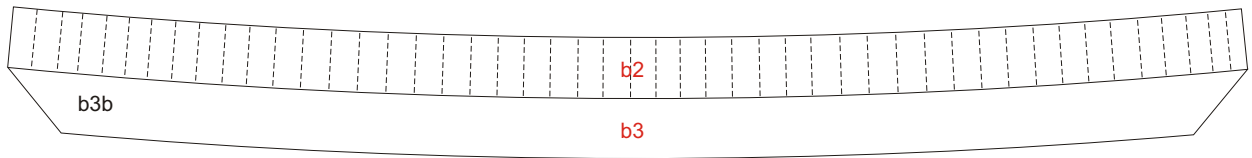

Internal parts of nozzles c1f and c1g

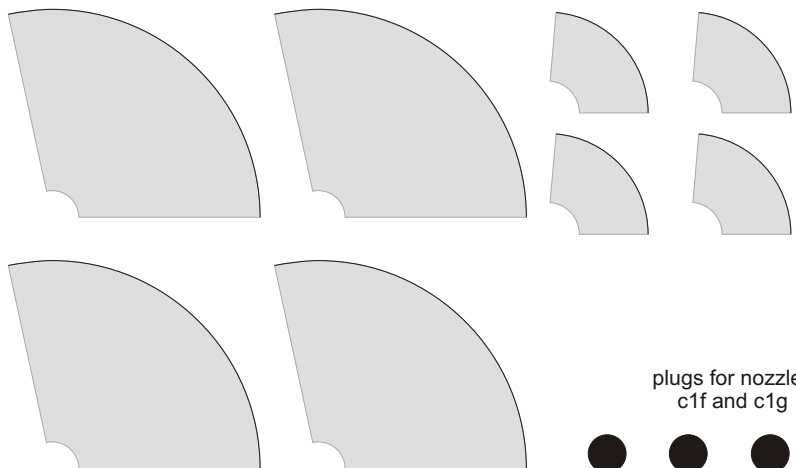

plugs for nozzles c1f and c1g

